



INT&RIOR SYSTEMS

creating quality ambient spaces

PRODUCT CATALOGUE

WELLINGTON

.....
AUGUST 2017
.....



Please check out our new and improved website!

www.tris.co.nz

CONTENTS

PRODUCT CATALOGUE 2017

SECTION 1	CEILINGS PG. 5
SECTION 2	WALLS PG. 27
SECTION 3	INSULATION PG. 37
SECTION 4	PROTECTION PG. 47
SECTION 5	ACCESSORIES PG. 53

Wellington Head Office
12 Glover St., Ngauranga
Wellington 6035

PO Box 38533
Wellington Mail Centre 5045

/t/ 04 499 5915
/f/ 04 499 5916

Auckland
19 - 21 Fairfax Ave.
Penrose, Auckland 1061

PO Box 112360,
Penrose, Auckland 1642

/t/ 09 571 0395
/f/ 09 571 0376

Christchurch
69 Disraeli St., Addington
Christchurch 8023

PO Box 7197
Christchurch 8240

/t/ 03 366 2507
/f/ 03 366 2508

0800 666 556
www.tr-interiorsystems.co.nz



INT&RIOR SYSTEMS
creating quality ambient spaces





CEILINGINGS

- Tiles & Panels
- Hatches
- Grid Systems
- Accessories
- Lighting



C MAX RANGE

C MAX ABSORB	PRODUCT CODE	DESCRIPTION	EDGE DETAIL	M ² CTN	TILES/ QTY	ORDER QTY
	TIGCM1212RE	C MAX ABSORB 1200x1200x25mm	Reveal Edge	11.52	8	
	TIGCM1212SE	C MAX ABSORB 1200x1200x25mm	Square Edge	11.52	8	
	TIGCM15RE	C MAX ABSORB 1200X600X15mm	Reveal Edge	14.40	20	
	TIGCM15RE3	C MAX ABSORB 1200X300X15mm	Reveal Edge	7.20	20	
	TIGCM15RE6	C MAX ABSORB 600X600X15mm	Reveal Edge	7.20	20	
	TIGCM15SE	C MAX ABSORB 1200X600X15mm	Square Edge	14.40	20	
	TIGCM15SEBLK	C MAX ABSORB BLK 1200X600X15mm	Square Edge	14.40	20	
	TIGCM15SL12	C MAX ABSORB 1200X600X15mm SL	Reveal Edge	14.40	20	
	TIGCM15SL6	C MAX ABSORB 600x600x15mm SL	Reveal Edge	7.20	20	
	TIGCM20RE6	C MAX ABSORB 600X600X20mm	Reveal Edge	5.40	15	
<p>C Max is a glass wool tile with a refined white painted monolithic pre-finished face. Extremely high performance acoustic absorption, this mid-range tile is extremely light weight, reducing the need for extensive seismic bracing. The glass-wool component also provides high thermal resistance coupled with low thermal conductivity which is excellent in helping maintain indoor temperature and also reducing energy consumption.</p>						

C MAX COMBO	PRODUCT CODE	DESCRIPTION	EDGE DETAIL	M ² CTN	TILES/ QTY	ORDER QTY
	TIGCM30CRE	C MAX COMBO 1200X600X30mm	Reveal Edge	3.6	5	
	TIGCM30CRE6	C MAX COMBO 600X600X30mm	Reveal Edge	3.6	5	
	TIGCM30CSE	C MAX COMBO 1200X600X30mm	Square Edge	3.6	5	
	TIGCM35CSE	C MAX COMBO 1200X600X35mm	Square Edge	3.6	5	
	TIGCM50CSE	C MAX COMBO 1200X600X50mm	Square Edge	2.88	4	
<p>C Max Combo is a glass wool tile with a refined white painted monolithic pre-finished face with a layer of 10mm plasterboard backer. This combination gives an extremely high Noise Reduction Co-efficient combined with a high CAC.</p>						

C MAX DIRECT FIX	PRODUCT CODE	DESCRIPTION	EDGE DETAIL	M ² CTN	TILES/ QTY	ORDER QTY
	TIGCM20DF6	C MAX DIRECT FIX 600X600X20mm	Concealed	5.4	15	
<p>C Max Direct Fix is a white painted, textured glass wool acoustic ceiling tile. This is a high end tile with a high NRC to reduce reverberation time. The construction and design of the compounded, high density glass-wool results in a light weight, high performance ceiling tile.</p>						

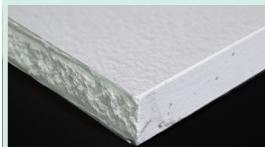
C MAX REFLECT	PRODUCT CODE	DESCRIPTION	EDGE DETAIL	M ² CTN	TILES/ QTY	ORDER QTY
	TIGCMR10WP	C MAX REFLECT 1200X600X9mm	Square Edge	4.32	6	
<p>C Max Reflect Gypsum Ceiling tiles have an extremely low noise reduction coefficient to aid direct reflections. Suitable for use in classrooms, lecture halls and where early reflections are desired.</p>						



CEILINGS



TILES & PANELS

C MAX RANGE

C MAX IMPACT	PRODUCT CODE	DESCRIPTION	EDGE DETAIL	M ² CTN	TILES/ QTY	ORDER QTY
	TIGCM40SEIPACTWHT	C MAX IMPACT 1200X600X40mm	Square Edge	5.76	8	
<p>C Max Impact Sports Panel is a 40mm thick fibre glass ceiling and wall panel with a strong fibre glass face. This panel has exceptionally high acoustic properties and is priced mid-range. The compounded, high density glass-wool design results in a light weight, durable, high performance sound panel.</p>						

SILENCE CLOUD	PRODUCT CODE	DESCRIPTION	EDGE DETAIL	M ² CTN	TILES/ QTY	ORDER QTY
	PASCBGE40SE	Silence Cloud Beige 2200x1200x40mm	Square Edge		2	
	PASCBLK40SE	Silence Cloud Black 2200x1200x40mm	Square Edge		2	
	PASCBLU40SE	Silence Cloud Blue 2200x1200x40mm	Square Edge		2	
	PASCNUE40SE	Silence Cloud Blank 2200x1200x40mm	Square Edge		2	
	PASCRE40SE	Silence Cloud Red 2200x1200x40mm	Square Edge		2	
	PASCTIM40SE	Silence Cloud Timber 2200x1200x40mm	Square Edge		2	
	PASCWHT40SE	Silence Cloud White 2200x1200x40mm	Square Edge		2	
<p>C Max Silence Cloud Sound Panel is a 40mm fabric wrapped glass wool panel with exceptionally high acoustic properties. It is ideal for use on walls in spaces 3m and higher; where acoustical ceilings are not sufficient to absorb sound. Custom Colours available on request</p>						





CEILINGS



TILES & PANELS

DAIKEN RANGE

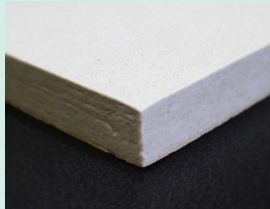
DAIKEN HARMONY	PRODUCT CODE	DESCRIPTION	EDGE DETAIL	M ² CTN	TILES/ QTY	ORDER QTY
	TIMDH19BR	HARMONY TILE 1200x600x19mm	Bevelled Reveal	5.76	8	
	TIMDH19BR3	HARMONY TILE 1200x300x19mm	Bevelled Reveal	5.76	8	
	TIMDH19BR6	HARMONY TILE 600x600x19mm	Bevelled Reveal	3.6	10	
	TIMDH19SE	HARMONY TILE 1200x600x19mm	Square Reveal	5.76	8	
	TIMDH19SE6	HARMONY TILE 600x600x19mm	Square Reveal	3.6	10	
<p>Daiken Harmony has a high Noise Reduction Coefficient and medium Ceiling Attenuation Class to help reduce reverberation time and to prevent sound transfer through the ceiling plenum. It has a smooth face and complies with many standard acoustic specifications.</p>						
DAIKEN DAI LOTONE	TIMDR9TG	DAIKEN DAI LOTONE RIBBED TILE 606X303X12mm Staple and Glue	Tongue and Groove	3.3	18	
	TIMDNR9TG	DAIKEN DAI LOTONE NON_RIBBED TILE 606X303X9mm Staple and Glue	Tongue and Groove	3.3	18	
<p>Daiken Dai Lotone is a white mineral fibre ceiling tile with a stippled texture and scattered pinhole finish. It has a medium Noise Reduction Coefficient (NRC) and is a great tile for use in education spaces.</p>						
DAIKEN VENUS MAX	TIMPVM19BR	DAI VENUS MAX 1200X600X19mm	Bevelled Reveal	7.2	10	
	TMDVM19BR6	DAI VENUS MAX 600X600X19mm	Bevelled Reveal	4.32	12	
	TIMDVM19SE	DAI VENUS MAX 1200X600X19mm	Square Edge	7.2	10	
<p>Daiken Venus Max is a white mineral fibre ceiling tile with a stippled texture and scattered pinhole finish. It has a High Noise Reduction Coefficient (NRC) and a medium Ceiling Attenuation Class (CAC) to help reduce reverberation time and prevent sound transfer through ceiling plenum.</p>						
DAIKEN CONSTELLATION	TIMDCFF12SE	DAI CONST TILE 1200X600X15mm	Square Edge	7.2	10	
	TIMDCFF13BR	DAI CONST TILE 1200X600X15mm	Bevelled Reveal	7.2	10	
	TIMDCFF13BR6	DAI CONST TILE 600X600X15mm	Bevelled Reveal	4.32	12	
	TIMDCFF13RE	DAI CONST TILE 1200X600X15mm	Reveal Edge	7.2	10	
	TIMDCFF13RE6	DAI CONST TILE 600X600X15mm	Reveal Edge	4.32	10	*
<p>Daiken Constellation tile has a white random perforated surface. It is an economical tile with medium NRC and CAC which helps to reduce reverberation time and prevent sound transfer through ceiling plenum.</p>						
DAIKEN VENUS	TIMDV12SE	DAI VENUS TILE 1200X600X15mm	Square Edge	7.2	10	
	TIMDV13BR	DAI VENUS TILE 1200X600X15mm	Bevelled Reveal	7.2	10	
	TIMDV13BR6	DAI VENUS TILE 600X600X15mm	Bevelled Reveal	4.32	12	
	TIMDV13RE	DAI VENUS TILE 1200X600X15mm	Reveal Edge	7.2	10	
<p>Daiken Venus is a white mineral fibre ceiling tile with a stippled texture and scattered pinhole finish. It has a medium Noise Reduction Coefficient (NRC) and a medium Ceiling Attenuation Class (CAC) to help reduce reverberation time and prevent sound transfer through ceiling plenum.</p>						

End of line. Stock on hand.

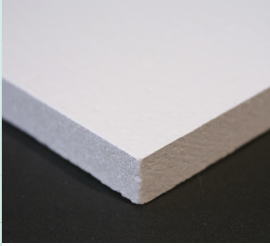

DAIKEN RANGE

DAIKEN PLAIN	PRODUCT CODE	DESCRIPTION	EDGE DETAIL	M ² CTN	TILES/ QTY	ORDER QTY
	TIMDP12SE	DAI PLAIN TILE 1200X600X12mm	Square Edge	7.2	10	
	TIMDP13BR	DAI PLAIN TILE 1200X600X13mm	Bevelled Reveal	7.2	10	
	TIMDP13BR6	DAI PLAIN TILE 600X600X13mm	Bevelled Reveal	4.32	12	
	TIMDP13RE6	DAI PLAIN TILE 600X600X13mm	Reveal Edge	4.32	12	
	TIMDP15RE6	DAI PLAIN TILE 600X600X15mm	Reveal Edge	4.32	12	
<p>Daiken Plain Mineral Fibre Ceiling tiles are non-fissured, with a smooth white painted surface. This is a favoured tile with contractors due to its robust dust free friendly nature. The Plain tile has a good CAC to prevent sound transfer through the ceiling plenum. Available in both square and rebated edge.</p>						

DAIKEN NEW NDF	PRODUCT CODE	DESCRIPTION	EDGE DETAIL	M ² CTN	TILES/ QTY	ORDER QTY
	TIMDN12SE	DAIKEN NDF TILE 1200X600X12mm	Square Edge	7.20	10	
	TIMDN12SEIMP	DAI NDF TILE 1220X606X12mm Imp	Square Edge	7.44	10	
	TIMDN13RE	DAI NDF TILE 1200X600X13mm	Reveal Edge	7.20	10	
	TIMDN13RE6	DAI NDF TILE 600X600X13mm	Reveal Edge	3.60	12	
	TIMDN13REIMP	DAI NDF TILE 1220X606X13mm Imp	Reveal Edge	7.44	10	
	TIMDN13SLRE6	DAI NDF TILE 600X600X13mm SL	Reveal Edge	3.6	12	
	TIMDN15FC	DAIKEN NDF 600x600x15mm	Fully Concealed	7.2	20	
	TIMDOWEN15	DAI NDF TILE 600X600x15mm	1 way	3.6/4.32	10/12	
	TIMDN15RE	DAI NDF TILE 1200X600X15mm RE	Reveal Edge	7.2	12	
	TIMDN15RE6	DAIKEN NDF 600x600x15mm RE	Reveal Edge	3.6	12	
	TIMDN15SE	DAI NDF TILE 1200X600x15mm SE	Square Edge	3.6/4.32	12	
<p>Daiken New NDF has a medium Noise Reduction Coefficient and medium Ceiling Attenuation Class to help reduce reverberation time and to prevent sound transfer through the ceiling plenum. It is the most economical tile in the Daiken Range.</p>						

DAIKEN CO-ORDINATE	PRODUCT CODE	DESCRIPTION	EDGE DETAIL	M ² CTN	TILES/ QTY	ORDER QTY
	TIMDC1015RE	DAI CO-ORD 10 TILE 1200X600X15mm	Rebated Edge	7.2	10	
	TIMDC2015RE	DAI CO-ORD 20 TILE 1200X600X15mm	Rebated Edge	7.2	10	
	TIMDC4015RE	DAI CO-ORD 40 TILE 1200X600X15mm	Rebated Edge	7.2	10	
	TIMDC4115RE	DAI CO-ORD 41 TILE 1200X600X15mm	Rebated Edge	7.2	10	
	TIMDC8115RE6SL	DAI CO-ORD 81 TILE 600X600X15mm	Rebated Edge	4.32	12	
<p>Daiken Co-Ordinate ceiling tiles have a white non-directional fissured scored board surface. This tile is a higher range product with good detailing where the manufacturing process offers clean precise scoring lines. This tile has a medium NRC and CAC to prevent sound transfer through the ceiling plenum.</p>						

End of line. Stock on hand.





SPECIAL APPLICATION

JEILLOUVER METAL	PRODUCT CODE	DESCRIPTION	EDGE DETAIL	M2 CTN	TILES/ QTY	ORDER QTY
	TISJMISC	Jeillouver indent order Tiles	NA	NA	NA	
	<p>Jeillouver Tiles are a perforated metal pan ceiling tile that offers high quality, immense flexibility with high aesthetic appeal made to order. Jeillouver Tiles have as standard, a black Soundtex Acoustic Cloth backing, to enhance the sound absorption. The Sound Absorption Coefficient (NRC) is dependant on the size and configuration of the perforations.</p>					

Indent order

GYPSUM VINYL	PRODUCT CODE	DESCRIPTION	EDGE DETAIL	M2 CTN	TILES/ QTY	ORDER QTY
	TIHVG10	Vinyl Gypsum Tile 1200x600x10	Square Edge	4.32	6	
	TIGCMRIOWP	C Max Reflect	Square Edge	4.32	6	
<p>The Gypsum Vinyl faced ceiling tile is a versatile, cost effective product that lends itself to a range of suspended ceiling applications. The tiles are supplied in a standard white finish, in a normal size of 1200 x 600 x 9mm. The moderately embossed facing gives a crisp clean monolithic look which ensures excellent light reflectance and the foil backing balances the tile, enhancing its dimensional tolerance whilst increasing thermal properties.</p>						

FENTA HYGIENE	PRODUCT CODE	DESCRIPTION	EDGE DETAIL	M2 CTN	TILES/ QTY	ORDER QTY
	TIHHA45SE	Fenta Tile 1200x600x4.5mm	Square Edge	0.72	1	
	<p>Fenta Hygiene ceiling tiles are white with a high-gloss polyurethane finish and are composed of an extremely durable Hardiflex base, coated with a two pack, non yellowing, high gloss polyurethane finish. Due to the hard, high quality and washable finish they are extremely resistant to chemical, steam and general soiling.</p>					

Phonic	PRODUCT CODE	DESCRIPTION	EDGE DETAIL	M2 CTN	TILES/ QTY	ORDER QTY
	<p>Phonic Anti-bacterial is a ceiling tile with a refined white painted, monolithic, pre-finished face. Extremely high Noise Reduction Coefficient of NRC 0.95.</p>					

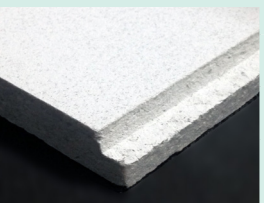

MARS CLIMAPLUS	PRODUCT CODE	DESCRIPTION	EDGE DETAIL	M2 CTN	TILES/ QTY	ORDER QTY
	TIMUM19RE	USG MARS Tile 1200 x 600 x 19RE	Reveal Edge	4.32	6	
	TIMUM19RE3	USG MARS Tile 1200 x 300 x 19RE	Reveal Edge	4.32	12	
	TIMUM19RE6	USG MARS Tile 600 x 600 x 19RE	Reveal Edge	4.32	12	
	TIMUM19SE	USG MARS Tile 1200 x 600 x 19SE	Square Edge	4.32	6	
	<p>MARS ClimaPlus is an X- Technology mineral fibre tile. It has high light reflectance, excellent noise reduction and scratch-resistance. It's durable with a cleanable surface and requires low maintenance.</p>					

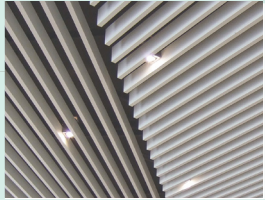

SPECIAL APPLICATION

ALUMINIUM BAFFLE		TBA long X 150mm wide	Square Edge		
		TBA long X 100mm wide	Square Edge		
	<p>The Aluminium Baffle is a linear ceiling, made up of extruded aluminium profiles. It can be installed with integrated lighting options, and powder coat options. Unlike timber, the baffle doesn't warp and maintains a clean look.</p>				

Colour TBA

Focus Baffle	PRODUCT CODE	DESCRIPTION	SIZE	TILES/ QTY
	<p>A new innovative application for cafes, restaurants, offices, boardrooms, classrooms and as a retrofit with a high NRC of 0.8. Focus polyester baffle sheets have been acoustically tested for sound absorption performance and perform very well with an airgap.</p>			
				

Colour TBA

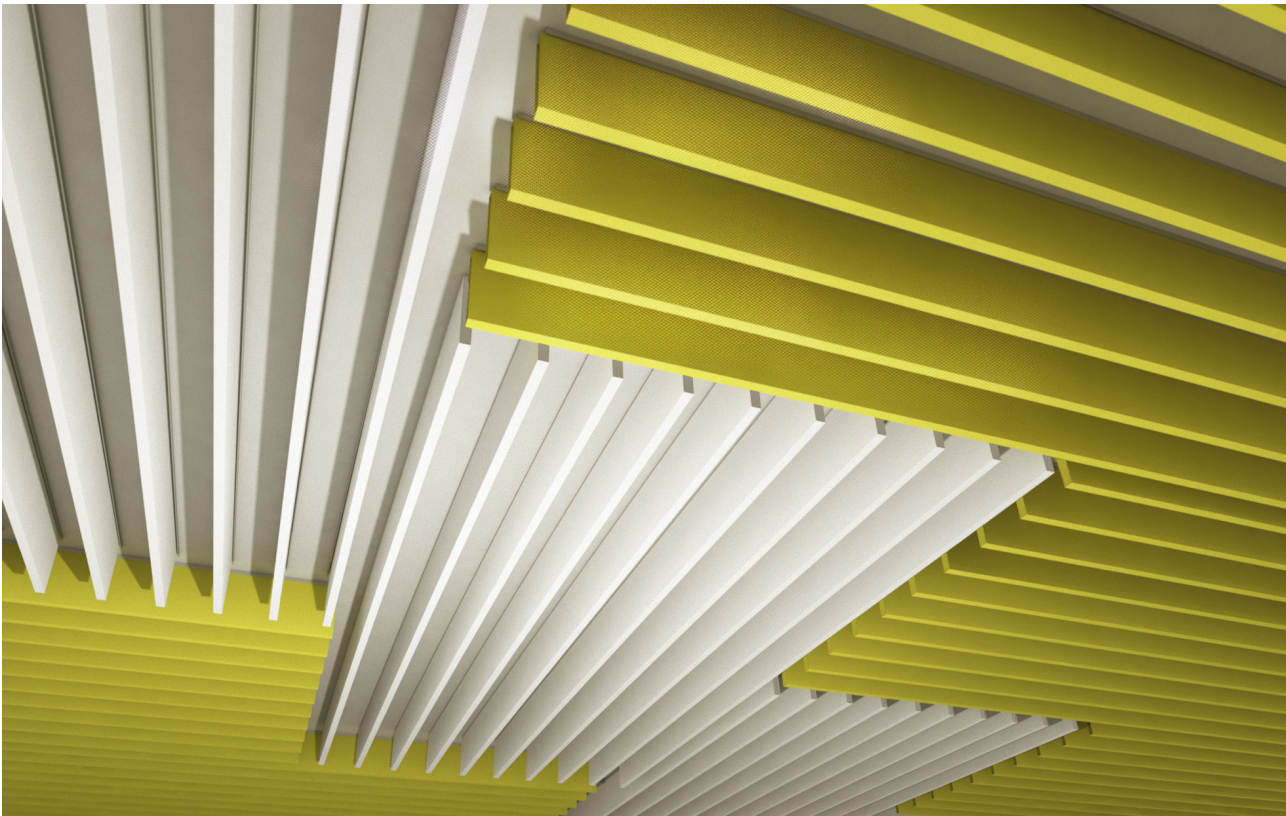



OROQI

OROQI 3D	PRODUCT CODE	DESCRIPTION	SIZE	TILES/ QTY	ORDER QTY
	TIPOC1194BLK	3D Ceiling Tile Black	1194x594	1	
	TIPOC1194COLOUR	3D Ceiling Tile Colour	1194x594	1	
	TIPOC1194WHT	3D Ceiling Tile White	1194x594	1	
	TIPOC594BLK	3D Tile Black	594x594	1	
	TIPOC594COLOUR	3D Tile Colour	594x594	1	
	TIPOC594WHT	3D Tile White	594x594	1	
<p>A new innovative application for cafes, restaurants, offices, boardrooms, classrooms and as a retrofit to reduce "Reverberation Time" in most commercial and education spaces. Available on indent.</p>					

NOVAHUSH

MAMOTH NOVAHUSH	PRODUCT CODE	DESCRIPTION	EDGE DETAIL	SIZE	PANEL/ QTY	ORDER QTY
	INNAPBLK	AC Panel Black 35-50	Square	2400 x 1200	6	
	INNAPWHT	AC Panel White 35-50	Square	2400 x 1200	6	
<p>Mammoth NOVAhush Panel Absorbers are semi-rigid boards in black, white or grey polyester. It is available as a plain product or with a thermally bonded black, polyester facing. NOVAhush Panel Absorber is for use in a wide range of thermal and acoustic application within commercial buildings – generally used as a surface mounted product.</p>						

ACCESSORIES

CLIPS	PRODUCT CODE	DESCRIPTION	QTY	ORDER QTY
	PASCCLIP	Silence Cloud Clip	1	
	PASCCLIPADJ	Silence Cloud Adjustable Suspension Clip	1	
	PASCCLIPSET	Silence Cloud Clip Set	1	
	PASCZC100ST	Zip Clip 100g Cable Lock	1	
	PASCZC150ST	Zip Clip 150g	1	
	TIGCLIPHD	Tie Hold Down Clip 15mm	1	
	TIGCLIPMUHD	Tie Hold Down Clip Metal	1	
	TIGCLIPMUHD1	Tie Hold Down Clip Metal	1	
	TIGCLIPMUHDA	Hold Down Clip Acoustic Panel	1	
	TIGCLIPMUHDS	Metal Sports Panel Tile Clip	1	
	TIGCLIPNUHD	Tie Hold Down Nylon Universal Clip	1	
	TIGCMCLIPDF	C Max Tile Clip DF	1	



CEILINGINGS



TILES & PANELS



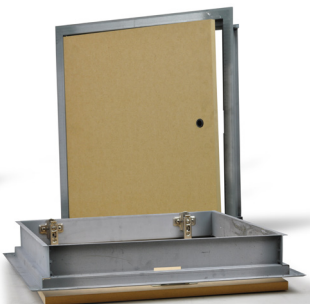

ACCESS HATCHES

FIRE RATED HATCHES	PRODUCT CODE	DESCRIPTION	SIZE (mm)	QTY	ORDER QTY
	HAFRSB300UH	Setbead Unihatch 1hr FR	300x300	1	
	HAFRSB450UH	Setbead Unihatch 1hr FR	450x450	1	
	HAFRSB530UH	Setbead Unihatch 1hr FR	530x530	1	
	HAFRSB560UH	Setbead Unihatch 1hr FR	560x560	1	
	HAFRFL300UH	Flanged Unihatch 1hr FR	300x300	1	
	HAFRFL450UH	Flanged Unihatch 1hr FR	450x450	1	
	HAFRFL530UH	Flanged Unihatch 1hr FR	530x530	1	
	HAFRFL560UH	Flanged Unihatch 1hr FR	560x560	1	
	HAFRSB300FP	Setbead Firepro 1hr FR	300x300	1	
	HAFRSB400FP	Setbead Firepro 1hr FR	400x400	1	
	HAFRSB450FP	Setbead Firepro 1hr FR	450x450	1	
	HAFRSB530FP	Setbead Firepro 1hr FR	530x530	1	
	HAFRSB600FP	Setbead Firepro 1hr FR	600x600	1	
	HAFRFL300FP	Flanged Firepro 1hr FR	300x300	1	
	HAFRFL400FP	Flanged Firepro 1hr FR	400x400	1	
	HAFRFL450FP	Flanged Firepro 1hr FR	450x450	1	
	HAFRFL530FP	Flanged Firepro 1hr FR	530x530	1	
	HAFRFL600FP	Flanged Firepro 1hr FR	600x600	1	

The T & R Interior Systems Fire Rated Access Hatches are a heavy duty core of industrial rockwool and hardwood meranti plywood with hardwood grooved lid and steel sheet tab system that provides hinged access through fire rated wall or ceiling to access electrical, plumbing or air conditioning equipment.

*Stock supply may vary branch to branch – please phone the branch for availability





ACCESS HATCHES

SET BEAD ACOUSTIC HATCH	PRODUCT CODE	DESCRIPTION	SIZE (mm)	QTY	ORDER QTY
	HASB300	Hatch Set Bead	300x300	1	
	HASB450	Hatch Set Bead	450x450	1	
	HASB530	Hatch Set Bead	530x530	1	
	HASB560	Hatch Set Bead	560x560	1	
	HASB600300	Hatch Set Bead	600x300	1	
	<p>The T & R Interior Systems' Set Bead Access Hatch is a high quality, laminated HDF Hatch that provides hinged access into any Plasterboard Ceiling, Wall or Bulkhead. Achieves an STC of 30dB.</p>				

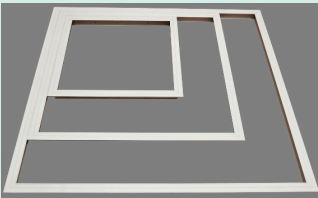
ALUMINIUM FRAME	PRODUCT CODE	DESCRIPTION	SIZE (mm)	QTY	ORDER QTY
	HAF300	Aluminium Frame	300x300	1	
	HAF450	Aluminium Frame	450x450	1	
	HAF600	Aluminium Frame	600x600	1	
<p>The T & R Aluminium Ceiling Frame is a high quality, white powder coated frame, specifically designed to allow simple, cost effective pre-finished access into a plasterboard ceiling.</p>					

HATCHES	PRODUCT CODE	DESCRIPTION	SIZE (mm)	QTY	ORDER QTY
	HAFRSL300	Hatch Flanged Std Lock	300x300	1	
	HAFRSL450	Hatch Flanged Std Lock	450x450	1	
	HAFRSL565	Hatch Flanged Std Lock	565x565	1	
	HAK300	Hatch Keylock	300x300	1	
	HAK450	Hatch Keylock	450x450	1	
	HAK565	Hatch Keylock	565x565	1	
<p>The T & R Interior Systems Aluminium Ceiling Hatch is a high quality, white, powder coated aluminium flanged hatch which allows for pre-decorated hinged access into any suspended ceiling, wall or bulkhead.</p>					

LIGHT DIFFUSERS

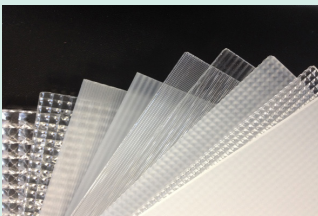
LIGHT DIFFUSERS	PRODUCT CODE	DESCRIPTION	SIZE (mm)	QTY	ORDER QTY
	G2DAIR	Diffuser Air	1200x500x9	1	
	G2DCLR	Diffuser Acrylic	1200x600x2.5	1	
	G2DEGG	Diffuser Ceiling Grid Insert	1194x595	1	
	G2DP	Diffuser Prismatic	1194x595	1	
	G2DP6	Diffuser Prismatic	594x594	1	
	<p>A selection of acrylic diffusers to provide maximum efficiency and good brightness control. The vents assist in the pressure control with the suspended ceiling tile system.</p>				



CEILING BATTEN/FURRING CHANNEL

SCREWFIX 22 & 35	PRODUCT CODE	DESCRIPTION	EDGE DETAIL	LENGTH (m)	QTY BDL/CTN	ORDER QTY
	GSTFC1636	Furring Channel	16mm	3.6	12-B	
	GSTFC1642	Furring Channel	16mm	4.2	12-B	
	GSTFC1648	Furring Channel	16mm	4.8	12-B	
	GSTFC223650	Furring Channel	22mm	3.6	12-B	
	GSTFC224850	Furring Channel	22mm	4.8	12-B	
	GSTFC2236	Furring Channel	22mm	3.6	12-B	
	GSTFC2248	Furring Channel	22mm	4.8	12-B	
	GSUFC2836	Furring Channel	23mm	3.6	12-B	
	GSTFC2836	Furring Channel	28mm	3.6	12-B	
	GSTFC2848	Furring Channel	28mm	4.8	12-B	
	GSTFC3536	Furring Channel	35mm	3.6	12-B	
	GSTFC3548	Furring Channel	35mm	4.8	12-B	
	GSTFC3560	Furring Channel	35mm	6.0	12-B	
	GSTPC1630	Perimeter Channel	16mm	3.0	12-B	
	GSTPC1636	Perimeter Channel	16mm	3.6	12-B	
	GSTPC2230	Perimeter Channel	22mm	3.0	12-B	
	GSTPC2236	Perimeter Channel	22mm	3.6	12-B	
	GSUPC2436	Perimeter Channel	22mm	3.6	12-B	
	GSTPC2830	Perimeter Channel	28mm	3.0	12-B	
	GSTPC2836	Perimeter Channel	28mm	3.6	12-B	
	GSTPC3530	Perimeter Channel	35mm	3.0	12-B	
	GSTPC3536	Perimeter Channel	35mm	3.6	12-B	
	GSTSB2536	Strongback	26.4mm	3.6	12-B	
	GSTSB2548	Strongback	26.4mm	4.8	12-B	
	GSTSB3836	Strongback	38mm	3.6	12-B	
	GSTSB3845	Strongback	38mm	4.5	12-B	
	GSTSB3840	Strongback	38mm	4.8	12-B	
	GSTSB3836FR	Strongback Fire rated	38mm	3.6	12-B	

The T & R Interior Systems' Screwfix System is a flexible, high quality, cold formed steel, direct fix or fully suspended grid system, specifically designed for screw fixing sheet linings to form flat monolithic ceilings, bulkheads and strapping. 3.6mtr lengths only ex Wellington branch. 4.2/4.8/6.0 mtr lengths available indent only – freight costs apply.



BACKING ANGLE

SCREWFIX	PRODUCT CODE	DESCRIPTION	EDGE DETAIL	LENGTH (m)	QTY BDL/ CTN	GAUGE	ORDER QTY
	GSTBA353055	Backing Angle	35x35	3.0	12-B	0.55	
	GSTBA353655	Backing Angle	35x35	3.6	12-B	0.55	
	GSTBAMF402455	Backing Angle	40x40	2.4	12-B	0.55	
	GSTBAMF403055	Backing Angle	40x40	3.0	12-B	0.55	
	GSTBAMF403655	Backing Angle	40x40	3.6	12-B	0.55	
	GSTBAMF4030115	Backing Angle	40x40	3.0	10-B	1.15	
	GSTBA5030115	Backing Angle	50x30	3.0	10-B	1.15	





CLIPS

CLIPS	PRODUCT CODE	DESCRIPTION	QTY	ORDER QTY
	G2UCLIPACM7	Seismic Wall Clip	100	
	G2UCLIPDC04	AC Hanger Bracket Clip (DC)	100	
	G2UCLIPGDH4	Seismic 4 way connection Clip	250	
	G2UCLIPSUS200	Suspension Clip MT/DF 200 (DFS)	500	
	G2UCLIPSUSCL315	Suspension Clip (CL315)	500	
	G2UCLIPTFS1	DX T Face Sleeve Clip	10	
	G2UCLIPREVOE	Clip REvoe (WSC18)	50	
	GSTCLIP1628AS	16/28mm DF Acoustic Short Clip	150	
	GSTCLIP1628L	16/28mm DF Long Clip	150	
	GSTCLIP1628S	16/28mm DF Short Clip	150	
	GSTCLIP2235AS	22/35 DF Clip Acoustic Short	150	
	GSTCLIP2235L	22/35 DF Clip Long	150	
	GSTCLIP2235S	22/35 DF Clip Short	150	
	GSTCLIP240	T&R Top Cross Rail Clip-240	150	
	GSTCLIP2RD1	T&R Clip - AC Concrete 2RD1	150	
	GSTCLIP348	T&R Clip Concrete (348)	150	
	GSTCLIP350	T&R Clip Strapping Concrete	500	
	GSTCLIPA98L	T&R Clip - AC DF 98 Long (DF19)	150	
	GSTCLIPA98S	T&R Clip- AC DF 98 Short (DF9)	150	
	GSTCLIPADJC54	T&R Clip - Adjustable Suspension Rod	150	
	GSTCLIPCR240	CR Top Cross Rail Clip - 240	150	
	GSTCLIPDF80	T&R DF Clips 80	80	
	GSTCLIPDF98S	T&R DF 98 Short Clips	500	
	GSTCLIPDFA1628L	T&R Wall Fix Clips 16/28 Long	150	
	GSTCLIPDFA1628S	T&R Wall Fix Clips 16/28 Short	150	
	GSTCLIPDFA2235S	T&R Wall Fix Clips 22/35 Long	150	
	GSTCLIPDFU	DF Long Universal Clip	150	
	GST CLIPFB	T&R Flat Bracket Clip 385	150	
	GSTCLIPFC16	T&R Furring Channel Joint Clip	100	
	GSTCLIPFC28	T&R Furring Channel Joint Clip	100	
GSTCLIPS3645	T&R Suspension Clip (3645)	100		
GSTCLIPST0011628	T&R AC Clip ST001 16/28mm	100		
GSTCLIPST0011628C	T&R Acoustic Clip to Strong Back 16/28	100		



CLIPS

CLIPS	PRODUCT CODE	DESCRIPTION	QTY	ORDER QTY
	GSTCLIPST0012235	T&R AC Clip ST001 22/35mm	100	
	GSTCLIPTC227	T&R Top Cross Rail Clip 94	100	
	GSTCLIPUL	DF Universal Long Clip Acoustic	50	
	GSTLCLIP1628S	16/28mm Short DF Clip	150	
	GSUCLIP AFC	USG AC Furring Channel Clip	100	
	GSUCLIP AHB	USG AC Hanger Bracket Clip (DC)	100	
	GSUCLIP AT	USG AC Transition Clip (DG-DX)	100	
	GSUCLIP CC	USG C Channel Clip (CC38)	200	
	GSUCLIP DF37L	USG Clip DF 37x193 Long (DF37)	200	
	GSUCLIP DF37S	USG Clip DF 37x97 Short (DF3S)	200	
	GSUCLIP M	USG Masonry Clip (MC37)	250	
	GSUCLIP SF	USG Snapfix Clip 37 (SC37)	200	
	GSUCLIP SPLICE	USG Splice Clip 180 (DGSC18)	50	
	GSUCLIP SS	USG Strongback Suspension Clip (CLO3)	500	
	GSUCLIP TR	USG Threaded Rod Clip (TR37)	250	
	GSUCLIP TRAN	USG Transition Clip 90 (DGTC9)	50	

Seismic Separation	PRODUCT CODE	DESCRIPTION	LENGTH	QTY	ORDER QTY
	GSTSPBMT36	T&R Suspended Plasterboard Grid Main Tee	3600	1	
	GSTSPBMTCT 12	T&R Suspended Plasterboard Grid Cross Tee	1200	1	
	GSTSPBMTCT 6	T&R Suspended Plasterboard Grid Cross Tee	600	1	
	Seismic Suspended Ceiling				



CEILINGS



GRID SYSTEMS

CBI

CBI 15 & 24 TWO WAY EXPOSED GRID	PRODUCT CODE	DESCRIPTION	SIZE	QTY BDL/ CTN	ORDER QTY	
 	G2CECT12	Exp Cross T Grid	24x1200	60		
	G2CECT1215	Exp Cross T Grid S	15x1200	88		
	G2CECT12BLK	Exp Cross T Grid Black	24x1200	60		
	G2CECT6	Exp Cross T Grid	24x600	60		
	G2CECT615	Exp Cross T Grid S	15x600	88		
	G2CECT6BLK	Exp Cross T Grid Black	24x600	60		
	G2CEMT37	Exp Main T Grid	24x3700	20		
	G2CEMT3715	Exp Main T Grid sl	15x3700	25		
	G2CEMT37BLK	Exp Main T Grid Black	24x3700	20		
	G2CEWA30	Exp Wall Angle	3000	50		
	G2CEWA30BLK	Exp Wall Angle Black	3000	50		
	G2CEWA30LL	Exp Wall Angle Long Leg	3000	40		
	G2CEWA30LLHD	Exp Wall Angle Long Leg Heavy Duty	40x20x3000	40		
	G2CEWA30SLLHD	CBI Seismic Wall Angle HD LL	40x20x3000	40		
	G2CEWA30SD	Exp Wall Angle Shadow	3000	40		
	G2CEWC30S	Exp Wall Channel Seismic	24x3000	18		
	<p>Both the Main Tee and Cross Tees are designed and manufactured in Italy using a hot dipped galvanized steel in a double web balanced tee design – in 3700mm lengths.</p>					

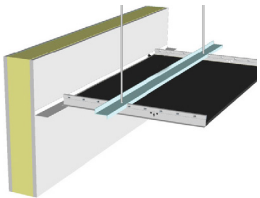
Z Rail	PRODUCT CODE	DESCRIPTION	SIZE	QTY	ORDER QTY
	G2SZR	Z Rail	3000	10	
	<p>Z Rails are a steel component to facilitate a T&R Seismic System Floating Edge. It is fixed to the top of the CBI grid tees to hold up the perimeter where the grid isn't fixed to walls.</p>				

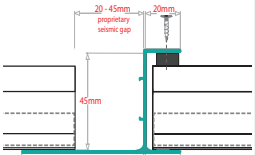
Seismic Separation	PRODUCT CODE	DESCRIPTION	LENGTH	QTY	ORDER QTY
	G2CSEJ30W	Aluminium Seismic Joint	3000	1	
	<p>Seismic Suspended Ceiling Separation Joint is a prefinished aluminium extrusion to be used in the seismic separation of ceilings. Design Registration # 420992.</p>				



CEILING



GRID SYSTEMS

USG BORAL

USG BORAL GRID	PRODUCT CODE	DESCRIPTION	SIZE	UNIT	ORDER QTY
 <p>USG BORAL INNOVATION INSPIRED BY YOU.™</p>	G2UECT12	Exp DX Cross T Grid	24x1200	60	
	G2UECT1215	Exp DXT Cross T Grid	15x1200	60	
	G2UECT1220	Exp DX Cross T Grid Imperi	24x4ft	60	
	G2UECT12BLK	Exp DX Cross T Grid Black	24x1200	60	
	G2UECT12FR	Exp DX Cross T Grid	24x1200	60	
	G2UECT12HD	Exp DX Cross T Grid	24x1200	60	
	G2UECT12WIDE	Exp DX Cross T Grid	38x1200	48	
	G2UECT6	Exp DX Cross T Grid	24x600	60	
	G2UECT610	Exp DX Cross T Imperial Gr	24x2ft	60	
	G2TUECT615	Exp DXT Cross T Grid	15x600	60	
	G2UECT6BLK	Exp DX Cross T Grid Black	24x600	60	
	G2UECT6HD	Exp DX Cross T Grid	24x600	60	
	G2UECT6WIDE	Exp DX Cross T Grid	38x600	48	
	G2UEMT36	Exp DX Main T Grid	24x3600	20	
	G2UEMT3615	Exp DXT Main T Grid	15x3600	20	
	G2UEMT3660	Exp DS Main T Deep Grid	24x3600	20	
	G2UEMT36BLK	Exp DX Main T Grid Black	24x3600	20	
	G2UEMT36FR	Exp DX Main T Grid	24x3600	20	
	G2UEMT36HD	Exp DX Main T Grid	24x3600	12	
	G2UEMT36WIDE	Exp DX Main T Grid	38x3600	16	
	G2UWA30SD	Exp DX Wall Angle 3000 Sha	3000	40	
	G2UWA36	Exp DX Wall Angle	3600	40	
	G2UWA3615	Exp DXT Wall Angle 3600 S	3600	40	
	G2UWA36BLK	Exp DX Wall Angle Black	3600	40	
	G2UWA36HD	Exp DX Wall Angle/Heavy Duty	3600	40	
	G2UWA36SDLL	Exp Wall Angle SD Longleg	3600	32	
	G2UWAML36LL	Exp DX Wall Angle Longleg	3600	12	
	G2UEWC36S	Seismic Wall Channel	3600	12	







CEILING

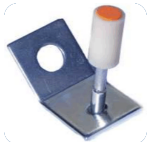

ACCESSORIES

WIRE

WIRE	PRODUCT CODE	DESCRIPTION	QTY	ORDER QTY
	G2HWPT121245	12' pre tied wire 45deg. AB45BKT	100	
	G2HWPT1212PS	12' Pre tied wire conc spike	100	
	G2HWPT1212PSDE	12' Pre tied wire conc spike D	100	
	G2HWPT1212ST	12' Pre tied wire steel eye	100	
	G2HWPT1212STDE	12' Pre tied wire steel eye D	100	
	G2HWPT1212TE	12' Pre tied wire timber eye	100	
	G2HWPT1212TEDE	12' Pre tied wire timber eye D	100	
	G2HW30	Hanger Wire 2.5x3000	100	
	G2HW36	Hanger Wire 2.5x3600	100	
	G2HW60	Hanger Wire 2.5x6000	100	
	G2HWPT124	12' Pre tired Wire 4' Long	100	
	G2HWPT124PS	4' Pre tied wire conc spike	100	
	G2HWPT124ST	4' Pre tied wire steel eye	100	
	G2HWPT124TE	4' Pre tied wire timber eye	100	
	G2HWPT126	12' Pre tied wire 6' long	100	
	G2HWPT12645	6' pre tied wire 45deg. AB45BKT	100	
	G2HWPT126ST	6' Pre tied wire steel eye	100	
	G2HWPT126TE	6' Pre tied wire timber eye	100	
	G2HWPT128	12' Pre tied wire 8' long	100	





CEILING



LIGHTING

T&R
GRID-LUX

Designed in the shape of a standard tee bar to allow it to substitute selected tees in the grid. Can be fully integrated or retrofitted into any type of suspended ceiling. Comes in White, Chrome, and Opaque colours, in both 600 & 1200 sizes. Please refer to the Grid-Lux brochure for more information.

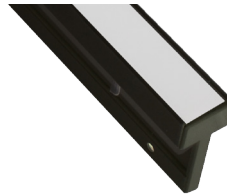

powered by

TRIDONIC



CEILING



LIGHTING

T&R
LED START PANEL

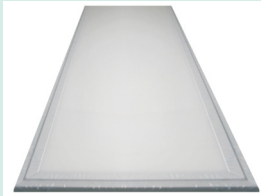

The T&R LED Start Panel has an average rated lamp life of 50,000 hours, and comes in 40W - 55W. It emits an even distribution of cool White light of 4000k, with recessed luminaires available in 3 sizes. Comes with a 5 year warranty.









WALLS

- Eclipse Aluminium Suite
- Tiles & Panels
- Stud & Track

500/008
MEETING ROOM



Eclipse Aluminium Suite



Contact T&R Interior Systems for full Eclipse Aluminium Suite catalogue



Eclipse Aluminium Suite



Contact T&R Interior Systems for full Eclipse Aluminium Suite catalogue



OROQI WALL

OROQI 3D WALL	PRODUCT CODE	DESCRIPTION	M ² CTN	TILES/ QTY	ORDER QTY
	TIPOW500BLK	3D Wall Tile Black	500x500	1	
	TIPOW500CHARCOAL	3D Wall Tile Charcoal	500x500	1	
	TIPOW500COLOUR	3D Wall Tile Colour	500x500	1	
	TIPO594BLK	3D Wall Tile Black	594x594	1	
	TIPO594COLOUR	3D Wall Tile Colour	594x594	1	
	TIPO594WHT	3D Wall Tile White	594x594	1	
	TIPOW600BLK	3D Wall Tile Black	600x600	1	
	TIPOW600CHARCOAL	3D Wall Tile Charcoal	600x600	1	
	TIPOW600COLOUR	3D Wall Tile Colour	600x600	1	
	TIPOW600WHT	3D Wall Tile White	600x600	1	

A new innovative application for cafes, restaurants, offices, boardrooms, classrooms and as a retrofit to reduce "Reverberation Time" in most commercial and education spaces. Suitable to use as wall panels. Ideal for use on walls in spaces 3m and higher; where acoustical ceilings are not sufficient to absorb sound. Available on indent.

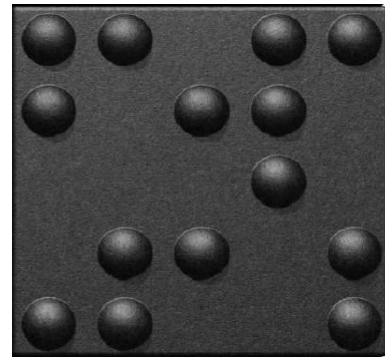
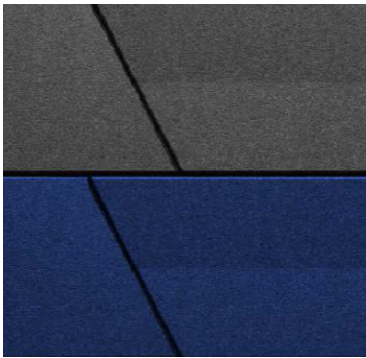



STEEL STUD

T&R STUD	PRODUCT CODE	DESCRIPTION	SIZE	GAUGE	QTY	ORDER QTY
	SST512450 *	T & R Stud 51 x 2400 .50g	51x2400	0.50	12-B	
	SST512455 *	T & R Stud 51 x 2400 .55g	51x2400	0.55	12-B	
	SST512755 *	T & R Stud 51 x 2700 .55g	51x2700	0.55	12-B	
	SST513050 *	T & R Stud 51 x 3000 .50g	51x3000	0.50	12-B	
	SST513055 *	T & R Stud 51 x 3000 .55g	51x3000	0.55	12-B	
	SST513655 *	T & R Stud 51 x 3600 .55g	51x3600	0.55	12-B	
	SST642450 *	T & R Stud 64 x 2400 .50g	64x2400	0.50	12-B	
	SST642455	T & R Stud 64 x 2400 .55g	64x2400	0.55	12-B	
	SST642750	T & R Stud 64 x 2700 .50g	62x2700	0.50	12-B	
	SST642755	T & R Stud 64 x 2700 .55g	64x2700	0.55	12-B	
	SST643050	T & R Stud 64 x 3000 .50g	64x3000	0.50	12-B	
	SST643055	T & R Stud 64 x 3000 .55g	64x3000	0.55	12-B	
	SST643350	T & R Stud 64 x 3000 .50g	64x3000	0.50	12-B	
	SST643355	T & R Stud 64 x 3000 .55g	64x3000	0.55	12-B	
	SST643655	T & R Stud 64 x 3600 .55g	64x3600	0.55	12-B	
	SST643955	T & R Stud 64 x 3900 .55g	64x3900	0.55	12-B	
	SST644250	T & R Stud 64 x 4200 .50g	64x4200	0.50	12-B	
	SST644255	T & R Stud 64 x 4200 .55g	64x4200	0.55	12-B	
	SST892455 *	T & R Stud 89 x 2400 .55g	89x2400	0.55	12-B	
	SST892755 *	T & R Stud 89 x 2700 .55g	89x2700	0.55	12-B	
SST893055	T & R Stud 89 x 3000 .55g	89x3000	0.55	12-B		
SST922455 *	T & R Stud 92 x 2400 .55g	92x2400	0.55	12-B		
<p>51mm, 75mm, 89mm 100mm and 150mm stud and track are available on request. Standard lengths, gauges and sized are available ex-stock. Special sizes, gauges and lengths are available upon request and require advance notice.</p>						

* Items available on indent order



STEEL STUD

T&R STUD	PRODUCT CODE	DESCRIPTION	SIZE	GAUGE	QTY	ORDER QTY
	SST922755	T & R Stud 92 x 2700 .55g	92x2700	0.55	12-B	
	SST923050 *	T & R Stud 92 x 3000 .50g	92x3000	0.50	12-B	
	SST923055	T & R Stud 92 x 3000 .55g	92x3000	0.55	12-B	
	SST923355 *	T & R Stud 92 x 3300 .55g	92x3300	0.55	12-B	
	SST923655 *	T & R Stud 92 x 3600 .55g	92x3600	0.55	12-B	
	SST923955 *	T & R Stud 92 x 3900 .55g	92x3900	0.55	6-B	
	SST924255 *	T & R Stud 92 x 4200 .55g	92x4200	0.55	6-B	
	SST924555 *	T & R Stud 92 x 4500 .55g	92x4500	0.55	6-B	
	SST924855 *	T & R Stud 92 x 4800 .55g	92x4800	0.55	6-B	
	SST925155 *	T & R Stud 92 x 5100 .55g	92x5100	0.55	6-B	
	SST926075 *	T & R Stud 92 x 6000 .75g	92x6000	0.75	6-B	
	SST15036115 *	T&R Stud 150 x 3600 1.15g	150X3600	1.15	6-B	
	<p>51mm, 75mm and 100mm stud and track are available on request. Standard lengths, gauges and sized are available ex-stock. Special sizes, gauges and lengths are available upon request and require advance notice.</p>					

Sold separately upon request

STOPEND CWOOD	PRODUCT CODE	DESCRIPTION	WIDTH	LENGTH	QTY	ORDER QTY
	SASTC9427RE	Stopend rebated Cwood	94	2.7	1	
	SASTC9436RE	Stopend rebated Cwood	94	3.6	1	
	SASTC12227RE	Stopend rebated Cwood	122	2.7	1	
	SASTC12236RE	Stopend rebated Cwood	122	3.6	1	

Whisper Wall	PRODUCT CODE	DESCRIPTION	SIZE	GAUGE	QTY	ORDER QTY
	SSTA923055 *	Acoustic Stud	92x3000	55	10-B	
	SSTA923655 *	Acoustic Stud	92x3600	55	10-B	
	SSTA923855 *	Acoustic Stud	92x3800	55	10-B	
<p>Made in New Zealand using NZ coil steel. Custom lengths available on request.</p>						

* Items available on indent order



STEEL TRACK

T&R Track	PRODUCT CODE	DESCRIPTION	SIZE	GAUGE	QTY	ORDER QTY
	STT15030115 *	T & R Track 150 x 3000 x 1.15G	150x3000	1.15	12-B	
	STT1503055 *	T & R Track 150 x 3000 .55g	150X3000	0.55	12-B	
	STT513055 *	T & R Track 51 x 3000 .55g	51X3000	0.55	12-B	
	STT642555 *	T & R Track 64 x 2500 .55g	64X2500	0.55	12-B	
	STT643055 *	T & R Track 64 x 3000 .55g	64X3000	0.55	12-B	
	STT893055	T & R Track 89 x 3000 .55g	89X3000	0.55	12-B	
	STT923055 *	T & R Track 92 x 3000 .55g	92X3000	0.55	12-B	
51mm, 75mm, 100mm and 150mm stud and track are available on request. Standard lengths, gauges and sized are available ex-stock. Special sizes, gauges and lengths are available upon request and require advance notice.						





NOG

T&R NOG	PRODUCT CODE	DESCRIPTION	SIZE	GAUGE	CENTERS	QTY	ORDER QTY
	STTN15030754C	T&R Track Nog	150X3000	0.75	400	10	
	STTN15030756C	T&R Track Nog	150X3000	0.75	600	10	
	STTN6430754C	T&R Track Nog	64X3000	0.75	400	10	
	STTN6430756C	T&R Track Nog	64X3000	0.75	600	10	
	STTN9230754C	T&R Track Nog	92X3000	0.75	400	10	
	STTN9230756C	T&R Track Nog	92X3000	0.75	600	10	
	STTN9236756C	T&R Track Nog	92X3600	0.75	600	10	

Please check for availability with local branch

TRACKLOK

TRACKLOK	PRODUCT CODE	DESCRIPTION	QTY	ORDER QTY
	AATRACKLOK	Seismic Partition Tie	10	
	AATRACKLOKR	Seismic Partition Tie - Retro	10	
	AATRACKLOKT	Seismic Partition Tie - Timber	10	
	AATRACKLOKV	Seismic Partition Tie Vertical	10	
		The Tracklok system secures partition walls and glazing lines, under ceiling to slab above. Designed and tested to mitigate risk to life and property and applicable to all seismic zones and all seismic loads. Meets or exceeds all national code requirements.		

GRIDLOK	PRODUCT CODE	DESCRIPTION	QTY	ORDER QTY
	G2GRIDLOK	Gridlok seismic Ceiling Bracket GRD - 10	10	
	Back bracing solution The patented GRIDLOK® connection saddle provides a solid bond to the two-way grid. It also features the ability to rotate the brace footprint through 360° meaning service clashes are easily avoided.			

GAPLOK	PRODUCT CODE	DESCRIPTION	QTY	ORDER QTY
	G2GAPLOK	Gaplok seismic Ceiling Bracket GRD - 10	10	
	On occasion, a partition wall or a glazing line placement may coincide with the main runners or nogs of two-way grid. In this instance there would be no way for a TRACKLOK® to pass through, with 10mm of clearance from the ceiling. GAPLOK allows you to take a 40mm section out of the grid, clamp GAPLOK to bridge the gap and reinstate the grid's structural integrity and allow the clearance required.			



TRACKLOK

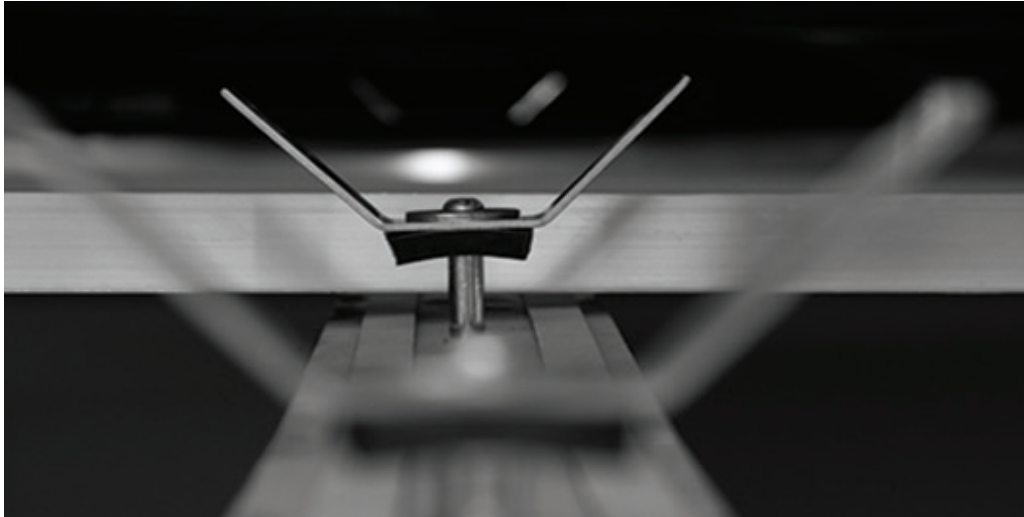





INSULATION

- Thermal
- Acoustic
- Additional Components





THERMAL





INSULATION



THERMAL

NOVATHERM

NOVATHERM	PRODUCT CODE	DESCRIPTION	NOMINAL THICKNESS	WIDTH (MM)	M ² P/BALE	ORDER QTY
	INNCBR18	Novatherm Ceiling Blanket R1.8	115mm	435	20	
	INNCBR22	Novatherm Ceiling Blanket R2.2	140mm	1200	13.79	
	INNCBR26	Novatherm Ceiling Blanket R2.6	175mm	870	15	
	INNCBR28	Novatherm Ceiling Blanket R2.8	185mm	870	15	
	INNCBR32	Novatherm Ceiling Blanket R3.2	200mm	870	15	
	INNCBR36	Novatherm Ceiling Blanket R3.6	225mm	870	13	
	INNF375	Novafloor R1.4 4.375x1200 6.3m ²	55mm	375	6.3	
	INNF435	Novafloor R1.4 4.435x1200 7.31m ²	55mm	435	7.31	
	INNF480	Novafloor R1.4 4.480x1200 7.57m ²	55mm	485	7.57	
	INNF580	Novafloor R1.4 4.580x1200 6.96m ²	55mm	580	6.96	
	INNWBR22	Novatherm Wall Blanket R2.2 58	90mm	580	7.5	
	<p>NOVatherm thermal insulation is made in New Zealand from 100% lofted thermally bonded polyester fibers. The polyester conjugate fibre used is crimped giving NOVatherm excellent durability. NOVatherm is designed for use in ceilings to provide thermal insulation. The air under the blanket, the air trapped in the fabric and the air inside the hollow fibres all contribute to the blanket insulation.</p>					



INSULATION



THERMAL

PINK BATTS

PINK BATTS	PRODUCT CODE	DESCRIPTION	NOMINAL THICKNESS	WIDTH (MM)	M2 P/BALE	ORDER QTY
	INPBCR22	Pink Batts Ceiling R2.2 12.6m	115	432	12.6	
	INPBCR26	Pink Batts Ceiling R2.6 10.5m	140	432	10.5	
	INPBCR32	Pink Batts Ceiling R3.2 8.4m2	170	432	8.4	
	INPBCR36	Pink Batts Ceiling R3.6 7.4m2	180	432	7.4	
	INPBCR40	Pink Batts Ceiling R4.0 6.3m2	195	432	6.3	
	INPBCR46	Pink Batts Ceiling R4.6 5.3m2	205	432	5.3	
	INPBCR50	Pink Batts Ceiling R5.0 4.2m2	210	432	4.2	
	INPBMR10	Pink Batts Masonry Wall R1.0	40	580	21.2	
	INPBMR12	Pink Batts Masonry Wall R1.2	50	580	17	
	INPBS100	Pink Batts Silencer 100 13.2m	100	580	13.2	
	INPBS75	Pink Batts Silencer 75 17.2m2	75	580	17.2	
	INPBSMF	Pink Batts Silencer Mid Floor	150	432	4.9	
	INPBSRR32	Pink Batts Skillion Roof R3.2	115	432	3.7	
	INPBSRR36	Pink Batts Skillion Roof R3.6	165	432	6.3	
	INPBSWR22	Pink Batts STI Wall R2.2 15.6	90	610	15.6	
	INPBSWR26	Pink Batts STI Wall R2.6 9.6	90	610	9.7	
	INPBWR18	Pink Batts Wall R1.8 19.2m2 B	90	580	17.2	
	INPBWR22	Pink Batts Wall R2.2 13.9m2 B	90	580	13.9	
	INPBWR24	Pink Batts Wall R2.4 10.6m2 B	90	580	10.6	
	INPBWR26	Pink Batts Wall R2.6 9.92m2 B	90	580	9.9	
	INPBWR28	Pink Batts Wall R2.8 6.61m2	90	580	6.6	
	INPBWR32	Pink Batts Wall R3.2 140 9.9	140	580	9.9	
	INPBWR36	Pink Batts Wall R3.6 140 7.3	140	580	7.3	
	INPBWR40	Pink Batts Wall R4.0 140 5.3	140	580	5.3	





INSULATION



THERMAL

BRADFORD GOLD

BRADFORD GOLD	PRODUCT CODE	DESCRIPTION	NOMINAL THICKNESS	WIDTH (MM)	M ² P/BALE	ORDER QTY
 	INBGAGDR18	Bradford Acoustic Gold R1.8	90	580	10.8	
	INBGAGDR22	Bradford Acoustic Gold R2.2	90	580	10.8	
	INBGAGR13	Bradford Acoustiguard R1.3	60	600	19.4	
	INBGAGR18	Bradford Acoustiguard R1.8	75	600	13.5	
	INBGCSR27	Bradford Gold Ceiling Seg R2.7	145	430	11.2	
	INBGCSR32	Bradford Gold Ceiling Seg R3.2	165	430	9	
	INBGCSR36	Bradford Gold Ceiling Seg R3.6	185	430	7.8	
	INBGCSR40	Bradford Gold Ceiling Seg R4.0	215	430	6	
	INBGCSR50	Bradford Gold Ceiling Seg R5.0	210	430	4	
	INBGCSR60	Bradford Gold Ceiling Seg R6.0	260	430	3	
	INBGCSR70	Bradford Gold Ceiling Seg R7.0	290	430	2	
	INBWCBR18	Bradford Gold Blanket WC R1.8	80	1200	18	
	INBWCBR29	Bradford Gold Blanket WC R2.9	115	1200	9.6	
	INBWCBR32	Bradford Gold Blanket WC R3.2	145	1200	12	
	INBWCBR36	Bradford Gold Blanket WC R3.6	164	1200	9	
	INBGWSR22	Bradford Gold Wall Seg R2.2	90	580	10.8	
	INBGWSR24	Bradford Gold Wall Seg R2.4	90	580	6.7	
	INBGWSR26	Bradford Gold Wall Seg R2.6	90	580	5.4	
	INBGWSR28	Bradford Gold Wall Seg R2.8	90	580	3.4	
	INBGWSR35	Bradford Gold Wall Seg R3.5	140	580	6.7	
	INBGWSR40	Bradford Gold Wall Seg R4.0	140	580	3.4	

Bradford Gold Wall Insulation has been designed to reduce unwanted noise entering through external walls, between rooms with the house when installed into internal walls. Bradford Gold Wall Insulation has been designed to reduce energy costs by keeping heat out in the summer and heat in during winter. Specially treated with a water repellent, a second line of defense in external walls is achieved and gives added protection to internal walls from water damage.

CSR	PRODUCT CODE	DESCRIPTION	THICKNESS	WIDTH	M ² P/BALE	ORDER QTY
	INBGUF26565	CSR Optimo Underfloor Insulation R2.6 - 565	565	52		
	INBGUF226415	CSR Optimo Underfloor Insulation R2 .6 - 415	415	5.8		

A rigid, high density insulation with excellent thermal and acoustic properties, specifically developed to increase the comfort, energy efficiency and safety of homes with timber floors.



INSULATION



THERMAL

BRADFORD GOLD

Xtratherm



The Xtratherm has a high thermal performance with rigid Insulation and non-deleterious material. Suitable for new building and refurbishment. Has a closed cell structure maintaining moisture resistance. Non-deleterious material.

- can be installed as a lining for timber or steel framing systems
- excellent thermal performance of the XtroLiner allows for very good U-values to be achieved whilst minimizing overall cavity wall thickness

Contact T&R for more information about Bradford Gold XtroLiner and XtraThrem insulation products.

KNAUF

KNAUF EARTHWOOL	PRODUCT CODE	DESCRIPTION	NOMINAL THICKNESS	WIDTH (MM)	M ² P/BALE	ORDER QTY
	INEWCBR18	Earthwool Ceiling Blanket R1.8	70mm	1200	16.2	
	INEWCBR29	Earthwool Ceiling Blanket R2.9	115mm	1200	10.2	
	INEWCBR32	Earthwool Ceiling Blanket R3.2	135mm	1200	9.6	
	INEWCBR36	Earthwool Ceiling Blanket R3.6	145mm	1200	8.4	
	INEWCSR27	Earthwool Ceiling Segment R2.7	125mm	430	12	
	INEWCSR32	Earthwool Ceiling Segment R3.2	150mm	430	10	
	INEWCSPCR3600MM	Earthwool Ceiling Segment R3.6	175mm	430	10.5	
	INEWCSR41	Earthwool Ceiling Segment R4.1	195mm	430	9	
	INEWCSR52	Earthwool Ceiling Segment R5.2	210mm	430	5.5	
	INEWCSPCR3600MM	Earthwool Ceiling Segment R3.6	145mm	1200	8.4	
	INEWWR26430	Earthwool Wall R2.6 90mm	90mm	580	7.0	
	INEWWR26580	Earthwool Wall R2.6 90mm	90mm	580	6.7	
	INEWCSR63	Earthwool Ceiling Segment R6.3	275mm	430	5.5	
	INEWWR22580	Earthwool Wall R2.2 90mm	90mm	580	25.57	
	INEWWR24580	Earthwool Wall R2.4 90mm	90mm	580	13.4	
	INEWWR28580	Earthwool Wall R2.8 90mm	90mm	580	14.8	
	INEWWR32	Earthwool Wall R3.2 140mm	140mm	430	14.8	
<p>EarthWool® glasswool rolls with ECOSE® Rolls technology is a new generation of super soft and highly sustainable glasswool, available in either segments or rolls. Earthwool® glasswool is a high quality insulation product with excellent thermal and acoustic performance. Environmentally friendly.</p>						



INSULATION



THERMAL

AUTEX

AUTEX	PRODUCT CODE	DESCRIPTION	NOMINAL THICKNESS	WIDTH (MM)	M ² P/BALE	ORDER QTY
	INAGBR18W	Autex GS Blanket R1.8	100	1200	13	
	INAGBR22W	Autex GS Blanket R2.2	150	1200	12.5	
	INAGBR26W	Autex GS Blanket R2.6	140	1200	9	
	INAGBR32W	Autex GS Blanket R3.2	190	1200	9	
	INAUTGSUFR18450W	Autex R1.8 UF R1.18	100	450	17.5	
	INAUTGSUFR18500W	Autex R1.8 UF R1.8	100	500	17.5	
	INAUTGSUFR18600W	Autex R1.8 UF R1.8	100	600	17.5	

AUTEX	PRODUCT CODE	DESCRIPTION	NOMINAL THICKNESS	WIDTH (MM)	M ² P/BALE	ORDER QTY
	INAQ1000W	Autex QS ASB 6 (1000gsm)	70	600	13.3	
	INAQ580W	Autex QS ASB 3 (580gsm)	50	600	19.8	
	INAQ750W	Autex QS ASB 4 (750gsm)	60	600	13.3	
	INAQ900W	Autex QS ASB 5 (900gsm)	70	600	13.3	
	INAQAAB3525BW	Autex QS AAB 35/25 Black Wgtn	25	600	28.8	
	INAQAAB3525BWW	Autex QS AAB 35 25 White Wgtn	25	600	28.8	
	INAQAAB3550BW	Autex QS AAB 35 50 Black	50	1200	14.4	
	INAQAAB3550WW	Autex QS AAB 35 50 White Wgtn	50	1200	14.4	
	INAQBAFWGTN	Autex QS Baffelblock	100	1200	10	

ACCESSORIES

ADDITIONAL COMPONENTS	PRODUCT CODE	DESCRIPTION	SIZE (mm)	QTY	ORDER QTY
	INADOMEAL	Domes Washer (Aluminium)	22	500	
	INADOMEBLK	Domes Washer (Black Colour)	22	500	
	INADOMEWHT	Domes Washer (White Colour)	22	500	
	INAPIN63	Insulation Pin	63	500	
	INAPIN89	Insulation Pin	89	500	
	INAPIN110	Insulation Pin	110	500	
	INAPIN160	Insulation Pin	160	500	
	INCAPSLC	Domes Self Lock Caps	22	500	
	INIA63	Metal Insulation Anchor	63	500	
	INIA89	Metal Insulation Anchor	89	500	
	INIA165	Metal Insulation Anchor	165	250	





INSULATION



THERMAL

AUTEX

NOVAHUSH	PRODUCT CODE	DESCRIPTION	NOMINAL THICKNESS	WIDTH (MM)	M ² P/BALE	ORDER QTY
 	INNAB580	Novahush AC Blanket 580gsm 600	60	600	30	
	INNAB750	Novahush AC Blanket 750gsm 600	60	600	20	
	INNAB900	Novahush AC Blanket 900gsm 580	90	600	20	
	INNABAF	Novahush Baffle Stack 120 20m	120	600	20	
<p>Mammoth NOVAhush Panel Absorbers are semi-rigid boards in black, white or grey polyester. NOVAhush Acoustic Blanket and Pads are typically used in timber framing and mid floors.</p>						

INSULPRO NOVAHUSH	PRODUCT CODE	DESCRIPTION	EDGE DETAIL	SIZE (mm)	PANEL/ QTY	ORDER QTY
	INNAPBLK	AC Panel Black 35-50	Square	2400x1200	6	
	INNAPWHT	AC Panel White 35-50	Square	2400x1200	6	
<p>INSULPRO NOVAhush Panel Absorbers are semi-rigid boards in black, white or grey polyester. It is available as a plain product or with a thermally bonded black, polyester facing. NOVAhush Panel Absorber is for use in a wide range of thermal and acoustic application within commercial buildings – generally used as a surface mounted product.</p>						





PROTECTION

- Floor Protection
- Packaging
- Body Protection

0
2113

2116

2119

2122

2125

2128

2131

2132



STICKY MAT

STICKY MAT	PRODUCT CODE	DESCRIPTION	ROLL SIZE	QTY BY PACK	QTY BY CARTON	ORDER QTY
	FLTSM610	T&R STICKY MAT	913 X 610 mm	30 sheets	8 packs	
	FLTSM913	T&R STICKY MAT	913 X 913 mm	30 sheets	8 packs	
	An innovative, multi-layered, self-adherent, stick mat. Designed to remove dirt, dust and residue from the bottom of foot-ware to protect access points. For industrial, commercial and residential applications.					

SELF STICK

SELF STICK	PRODUCT CODE	DESCRIPTION	ROLL SIZE	M ² PER ROLL	ORDER QTY
	FLTSS100	T&R SELF STICK	1X100m	100	
	FLTSS500	T&R SELF STICK	0.5mm X 100m	50	
	FLTSTV100	T&R SELF STICK VINYL	1MX100m	100	
	FLTSTV50	T&R SELF STICK VINYL	0.5mm X 100m	50	
New improved 90micron carpet and 80micron hand floor surface protection – Pressure sensitive adhesive allowing clean and easy removal.					

POLYWOVEN

T&R POLYWOVEN	PRODUCT CODE	DESCRIPTION	ROLL SIZE	M ² PER ROLL	ORDER QTY
	FLTLWPWBLU	POLYWOVEN 75MICRONS BLUE ROLL	2X100m	200	
	FLTPWBLU	POLYWOVEN 100MICRONS BLUE ROLL	2x50m	100	
	FLTPWHD	POLYWOVEN (HEAVY DUTY)	2x100m	200	
Polywoven is an industry proven, cost effective way to protect surfaces and materials for interior and exterior projects. Polywoven water and water resistant material for interior/exterior applications.					

CLEAR COVER

CLEAR COVER	PRODUCT CODE	DESCRIPTION	ROLL SIZE	M ² PER ROLL	ORDER QTY
	FLTCC	CLEAR COVER	4x100m	400	
Ideal for commercial fit-outs and industrial developments by reducing dust and grime getting into equipment of existing work-spaces.					



PROTECTION

SHOE DISPENSER		PRODUCT CODE	DESCRIPTION	QTY		ORDER QTY
		FLASD	Auto Shoe Dispenser	1		
		FLASR	Auto Show Dispenser Refill	100		
SEISMIC GRID PLASTIC COVER		G2ATSPC	Seismic Grid Plastic Cover	100		
GUARD BOARD		FLTGB15	Guard Board HD (13.5m ²)	0.9x15m	Roll	
		FLTGB30	Guard Board HD (27m ²)	0.9x30m	Roll	
		FLTGB45	Guard Board HD (45m ²)	0.9x50m	Roll	
RAMBOARD		FLRAMBOARD	Ram Board	0.9x30.5m	Roll	

PACKAGING

CARDBOARD		PRODUCT CODE	DESCRIPTION	SIZE (m)	QTY	ORDER QTY
		MICC9007500	Corrugated Cardboard	0.9x75m	Roll	
		MICC12007500	Corrugated Cardboard	1.2x75m	Roll	
		MICC18007500	Corrugated Cardboard	1.8x75m	Roll	
BUBBLE WRAP		MIP900100	Bubble Wrap	0.9x100m	Roll	

BODY PROTECTION

GLASSES		PRODUCT CODE	DESCRIPTION	QTY	ORDER QTY
		TLASGLASSESCLEAR	Safety Glasses (Clear)	1	
		TLASGLASSESSMOKE	Safety Glasses (Smoke)	1	
		TLASGVEXISC	Vexis Safety Glasses (Clear)	1	
		TLAGLASSES MAGNUM	Magnum Wrap Around Safety Spec (Clear Antifog) Wgtn	1	
		TLAGLASSESVELOCITY	Velocity: Safety Spec (Clear Lens) Wgtn	1	



BODY PROTECTION

GLOVES		PRODUCT CODE	DESCRIPTION	QTY	ORDER QTY
		TLAGLOVESBKM	Black Knight Multipurpose Gloves	1	
		TLAGLOVESBKT	Black Knight Thermal Gloves-Sub Zero	1	
		TLAGLOVESC	Cotton Gloves	12	
		TLAGLOVESHIELD	Gloves Shield Cut Resistant	1	
		TLAGLOVESK	Cotton Knitted Gloves	1	
		TLAGLOVESPP	Gloves Palm Protection	1	
OVERALLS		TLAOVERRALLS	DUST OVERALLS	1	
		Sizes: M L XL XXL			
HARD HAT		TLAARMUFFHRDHAT	Hard Hat Ear Muff Class 5 CLC80 26DB	1	
		TLAHARDHATYELL	Tuff-Nut Hard Hat Short Peak Vented Yellow	1	
		TLAHARDHATWHT	Tuff-Nut Hard Hat Short Peak Vented White	1	
EAR PROTECTION		TLAARMUFFBANDED	X300 Banded Ear Muff 26DCLB Class 5	1	
		TLAARMUFFFOLDING	X600 Folding Ear Muff Class 5 33D8	1	
		TLAEARPLUGSPROBELL	Pro Bell Yellow Bell Ear Plugs (Foam Uncorded)	200	
RESPIRATOR MASKS		TLAMASK 12	Dust Mask Valved P2	12	
		TLAMASK 20	Dust Mask Non Valved P1	20	





ACCESSORIES

- Hand Tools
- Measuring Devices
- Knives/Blades
- Tape
- Adhesives
- Sanding
- Scaffolding
- Drill Bits
- Fasteners
- Miscellaneous



ACCESSORIES



ACCESSORIES

HAND TOOLS

SNIPS		PRODUCT CODE	DESCRIPTION	QTY	ORDER QTY
		TLTMETALSNIPS	WISS METAL SNIPS	1	
		TLTSNIPS	SNIPS STERLING AVIATION	1	
RIVETER		TLTRIVET	Jaw Rivet Tool	1	
CRIMPER		TLTSTUDCRIMPER	Stud and Track Crimper	1	
PLIER		TLTPLIER	Plier 200mm	1	
GRID ON CRIMPER		TLTGRIDCRIMPER	Grid Crimper	1	
VICE GRIPS		TLTWISECRIPCC	Vice Grip C Clamo	1	
		TLTWISECRIPLN	Vice Grip Longnose	1	
		TLTWISECRIPSJ	Vice Grip Straight Jaw 175	1	
		TLTWISEGRIPCJ	Vice Grip Curved Jaws 5"	1	





ACCESSORIES



ACCESSORIES

HAND TOOLS

PUNCH		PRODUCT CODE	DESCRIPTION	QTY	ORDER QTY
		TLTGRIDPUNCH	Punch Plier- Grid Punches	1	

HAMMER		PRODUCT CODE	DESCRIPTION	QTY	ORDER QTY
		TLTHAMMER	Fibre Glass Claw Hammer	1	

EYESCREW DRIVERS		PRODUCT CODE	DESCRIPTION	QTY	ORDER QTY
		TLAEYEDRIVERBIT	Eyescrew Driver Bit	1	
		TLAEYESCREW	Eyescrew Rep Driver Head	1	
		TLAEYESCREWHEADWE	Eyescrew Rep Head (wire end)	1	
		TLAEYESCREWPOLE4	Eyescrew Pole 4ft	1	
		TLAEYESCREWPOLE6	Eyescrew Pole 6ft	1	
TLAEYESCREWPOLE8	Eyescrew Pole 8ft	1			









ACCESSORIES

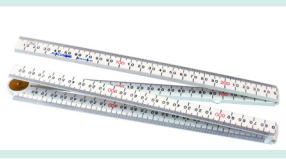

ACCESSORIES

MEASURING DEVICES

TAPE MEASURE		PRODUCT CODE	DESCRIPTION	QTY	ORDER QTY
		TLTTAPE	TAPE MEASURE 8M T&R	1	
STRING LINE		TLASTRINGLINE	FLURO STRINGLINE 80m	1	
RULER		TLTRULE	18mm White Nylon Ruler	1	
		TLTSQRULE	Combination Square Ruler	1	
DIGITAL CALIPER		TLTCALIPER150	FAI Caldig Digital Caliper	1	
PLASTEREX LEVEL		TLTLEVEL	Plasterex Level	1	
LASER EQUIPMENT		TLTLASER30	Laser Bullseye 30 Pen	1	
		TLTLASER22	Laser Crossliner	1	
		TLTLASER33	Laser Trilater	1	
		TLTLASER33G	Laser Tri Liner Green Beam	1	
		TLTLASER55	Laser Masterline 55	1	
		TLTLASER88G	Laser Self Lev-Rotation (Green)	1	
		TLTLASER88R	Laser Self Lev Rotation	1	
		TLTLASERMINITRIPOD	Laser Mini Tripod	1	
		TLTLASERWALLBRKT	Laser Wall Verticle Bracket	1	





ACCESSORIES







ACCESSORIES

KNIVES & BLADES

KNIVES		PRODUCT CODE	DESCRIPTION	QTY	ORDER QTY
		TLTKNIFEAL	Knife Autoloading	1	
		TLTKNIFE25	T&R 25 Knife	1	
BLADES		PRODUCT CODE	DESCRIPTION	QTY	ORDER QTY
		TLABLADE	Blades HD	5	
		TLABLADEHD	Heavy Duty Trim Blade	10	
SAW		PRODUCT CODE	DESCRIPTION	QTY	ORDER QTY
		TLTINSULSAW	INSULATED HANDSAW 550mm	1	

PLASTERING & PUTTY

FLEX S/S PUTTY KNIFE		PRODUCT CODE	DESCRIPTION	QTY	ORDER QTY
		TLTM0008	1 1/2" Flex S/S Putty Knife	1	
		TLTM0009	2" Flex S/S Putty Knife	1	
FLEX STAINLESS JOINT KNIFE		PRODUCT CODE	DESCRIPTION	QTY	ORDER QTY
		TLTM0010	Flex Stainless Joint Knife 3"	1	
		TLTM0011	Flex Stainless Joint Knife 4"	1	
		TLTM0012	Flex Stainless Joint Knife 5"	1	
		TLTM0013	Flex Stainless Joint Knife 6"	1	
FLEX CARBON JOINT KNIFE		PRODUCT CODE	DESCRIPTION	QTY	ORDER QTY
		TLTM0014	Flex Carbon Joint Knife 3"	1	
		TLTM0015	Flex Carbon Joint Knife 4"	1	
		TLTM0016	Flex Carbon Joint Knife 5"	1	
		TLTM0017	Flex Carbon Joint Knife 6"	1	
STAINLESS JOINT KNIFE		PRODUCT CODE	DESCRIPTION	QTY	ORDER QTY
		TLTM0018	Pro Stainless Joint Knife 3"	1	
		TLTM0019	Pro Stainless Joint Knife 4"	1	
		TLTM0020	Pro Stainless Joint Knife 5"	1	
		TLTM0021	Pro Stainless Joint Knife 6"	1	



ACCESSORIES





ACCESSORIES

PLASTERING & PUTTY

		PRODUCT CODE	DESCRIPTION	QTY	ORDER QTY
		TLTM0024	MAXXGRIP Pro Jab Saw	1	
HYDE		TLTM0026	11" x 4-1/2" C/S Finishing Trowel	1	
CORNER TOOLS		TLTM0029	Inside Corner Tool	1	
		TLTM0028	Outside Corner Tool	1	

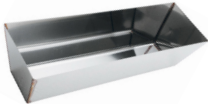
HYDE PLASTER

		PRODUCT CODE	DESCRIPTION	QTY	ORDER QTY
MUD PAN		TLTM0025	12" Stainless Steel Mud Pan	1	
CORNER ROLL COVERS		TLTM0027	Wool Corner Roller Covers	1	

ADHESIVES

		PRODUCT CODE	DESCRIPTION	QTY	ORDER QTY
ADHESIVES		FABAS	Bostik AC Sealant	20	
		FABFRA	Bostik Fire Rated Adhesive	20	
		FABWBA	Bostik Water Based Adhesive	20	
		FABWGS	Bostik W/Bd Gold 600ml Sausage	20	



ACCESSORIES



TAPES

TAPE

TAPE CLOTH		PRODUCT CODE	DESCRIPTION	LENGTH (M)	UNIT	ORDER QTY
		TAPECLOTHBEIGE	TAPE CLOTH BEIGE	.048 x 30	20	
		TAPECLOTHBLUE	TAPE CLOTH BLUE	.048 x 30	18	
		TAPECLOTHFOIL	TAPE CLOTH FOIL	.048 x 30	8	
		TAPECLOTHWHITE	TAPE CLOTH WHITE	.048 x 30	20	
TAPE INSEAL		TAPEINSEAL324	TAPE INSEAL 3X24X25M	.03x.024x25	1	
		TAPEINSEAL36	TAPE INSEAL 3X6X25M	.03x.06x25	1	
		TAPEINSEAL39	TAPE INSEAL 3X9X25M	.03x.09x25	1	
		TAPEINSEAL615	TAPE INSEAL 6X15X25M	.06x.015x25	1	
		TAPEINSEAL69	TAPE INSEAL 6X9X12M	.06x.09x12	1	
TAPE FIBRE		TAPEFIBRE153	TAPE FIBRE 153M	153	16	
		TAPEFIBRE90	TAPE FIBRE 90M	90	16	
FIBRE FUSE		TAPEFIBREFUSE	TAPE FIBRE FUSE (PLASTERBOARD)	.076x20	20	
RAM TAPE		TAPERAMBOARD	RAM TAPE 48MMX55M	.048x55	20	







ACCESSORIES



TAPES

TAPE

		PRODUCT CODE	DESCRIPTION	SIZE	QTY	ORDER QTY
PVC TAPE		TAPEPVC	Black PVC Tape	48x30m	36	
WATER SEAL		TAPEH20MD66BLK	Water Seal Tape MD66BLK	-	1	
SEALING TAPE		TAPEGRDBDCLR	Clear Tape for Guard-board	48x50	1	
OTHER		TAPESTRAITFLEX	Straitflex	30.5m	1	
		TAPEPAPER	Tape Paper	50x150m	16	







ACCESSORIES



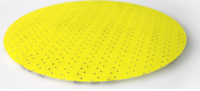



ACCESSORIES

SANDING ACCESSORIES

HAND SANDING		PRODUCT CODE	DESCRIPTION	QTY	ORDER QTY
		TLASSPONGEA	Sanding Sponge Angle	10	
		TLASSPONGESQ	Sanding Sponge SQ	10	
GIRAFFE SANDING		TLASANDDISK180	Giraffe Sanding Disk 180 Grit	25	
		TLASANDDISK220	Giraffe Sanding Disk 220 Grit	25	
POLE SANDING		TLTM0004	Aluminium Pole Sander Head Hyde	1	
		TLAPOLESPAPER180	Pole Sanding Paper SQ 180 Grit	20	
		TLAPOLESPAPER220	Pole Grit Sanding Paper SQ 220	20	
HAND SANDER		TLTM0005	Hand Sander -Easy Clamp Hyde	1	
VACCUUM SANDER		TLTM0023	Vac. Hand Sander with Hose	1	
SANDSCREEN		TLTM0032	Hyde Precut Drywall Sand-screen: 180 Grid, Medium 45 Mesh	2	
		TLTM0033	Hyde Precut Drywall Sand-screen: 220 Grit, Fine 45 Mesh	2	

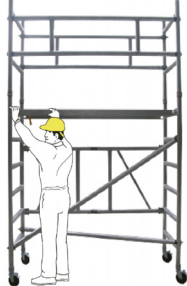

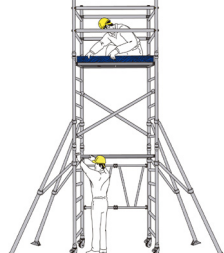
SCAFFOLDING

SCAFFOLD FRAMES		PRODUCT CODE	DESCRIPTION	QTY	ORDER QTY
		TLTSCAF18	1.8m Aluminium Scaffold Frame	1	
		TLTSCAF35	3.5m Aluminium Scaffold Frame	1	
		TLTSCAF35D	Scaffold Double	1	
		TLTSCAF35T	Scaffold Triplicate	1	



SCAFFOLDING

SCAFFOLD ACCESSORIES		PRODUCT CODE	DESCRIPTION	QTY	ORDER QTY
		TLTSCAFAW	Scaffold Adjustable Wheel	1	
		TLTSCAFB35	Scaffold Toe Board 1400x600	1	
		TLTSCAFB18	Scaffold Toe Board Set 1800x600	1	
		TLTSCAFBB18	Scaffold 1942 Bottom Brace	1	
		TLTSCAFDB18	Scaffold Diagonal Brace	1	
		TLTSCAFDB35	Scaffold Diagonal Brace 1633	1	
		TLTSCAFGR3518	Scaffold Guard Rail 1000x680	1	
		TLTSCAFHL35	Scaffold Hook Ladder 1740	1	
		TLTSCAFHSGR18	Scaffold H Style Guard Rail 1720x350	1	
		TLTSCAFHSGR35	Scaffold H Style Guard Rail 1400x350	1	
		TLTSCAFPH18	Scaffold Platform with Hatch 1800x600	1	
		TLTSCAFPH35	Scaffold Platform with Hatch 1400x600	1	
		TLTSCAFSTAB	Stabilizer Legs for 3.5m Alu Scaf.	1	
		TLTSCAF6RF35	Scaffold Six Rung Frame 1782x680	1	
		TLTSCAF6RLF35	Scaffold Six Rung Left Frame 1782x680	1	
		TLTSCAF6RRF35	Scaffold Six Rung Right Frame 1782x680	1	
		TLTSCAFHSGR	Scaffold Six Rung Right Frame 1782x680	1	
		TLTSCAFEFF35	Scaffold End Frame- Folding 1329x892	1	



ACCESSORIES



ACCESSORIES

DRILL BITS

SDS+Zentro
MASONARY DRILL
BITS



PRODUCT CODE	DESCRIPTION	SIZE	QTY	ORDER QTY
TLADBS050110	SDS+Zentro Mas Drill	5x110	1	
TLADBS050160	SDS+Zentro Mas Drill	5x160	1	
TLADBS055110	SDS+Zentro Mas Drill	5.5x110	1	
TLADBS055160	SDS+Zentro Mas Drill	5.5x160	1	
TLADBS060110	SDS+Zentro Mas Drill	6x110	1	
TLADBS060160	SDS+Zentro Mas Drill	6x160	1	
TLADBS065110	SDS+Zentro Mas Drill	6.5x110	1	
TLADBS065160	SDS+Zentro Mas Drill	6.5x160	1	
TLADBS065210	SDS+Zentro Mas Drill	6.5x210	1	
TLADBS080160	SDS+Zentro Mas Drill	8x160	1	
TLADBS080210	SDS+Zentro Mas Drill	8x210	1	
TLADBS100160	SDS+Zentro Mas Drill	10x160	1	
TLADBS100210	SDS+Zentro Mas Drill	10x210	1	
TLADBS120160	SDS+Zentro Mas Drill	12x160	1	
TLADBS120210	SDS+Zentro Mas Drill	12x210	1	
TLADBS160260	SDS+Zentro Mas Drill	16x260	1	
TLADBS180250	SDS+Zentro Mas Drill	18x250	1	
TLADBS200250	SDS+Zentro Mas Drill	20x250	1	
TLADBS220250	SDS+Zentro Mas Drill	22x250	1	
TLADBS240250	SDS+Zentro Mas Drill	24x250	1	
TLADBS250250	SDS+Zentro Mas Drill	25x250	1	



ACCESSORIES



ACCESSORIES

HSS DRILL BITS

HSS ALPHA



PRODUCT CODE	DESCRIPTION	SIZE (mm)	QTY	ORDER QTY
TLADBS9D11	Alpha Gold Drills D/E	4.9	1	
TLADBS9D20	Alpha Gold Drills D/E	4.1	1	
TLADBS9D30	Alpha Gold Drills D/E	3.3	1	
TLADBSMSET	Alpha Gold Drills Set	-	25	
TLADBSM010	Alpha Jobber Drill	1.0	1	
TLADBSM015	Alpha Jobber Drill	1.5	1	
TLADBSM020	Alpha Jobber Drill	2.0	1	
TLADBSM025	Alpha Jobber Drill	2.5	1	
TLADBSM030	Alpha Jobber Drill	3.0	1	
TLADBSM033	Alpha Jobber Drill	3.3	1	
TLADBSM035	Alpha Jobber Drill	3.5	1	
TLADBSM040	Alpha Jobber Drill	4.0	1	
TLADBSM045	Alpha Jobber Drill	4.5	1	
TLADBSM050	Alpha Jobber Drill	5.0	1	
TLADBSM055	Alpha Jobber Drill	5.5	1	
TLADBSM060	Alpha Jobber Drill	6.0	1	
TLADBSM065	Alpha Jobber Drill	6.5	1	
TLADBSM070	Alpha Jobber Drill	7.0	1	
TLADBSM075	Alpha Jobber Drill	7.5	1	
TLADBSM080	Alpha Jobber Drill	8.0	1	
TLADBSM085	Alpha Jobber Drill	8.5	1	
TLADBSM090	Alpha Jobber Drill	9.0	1	
TLADBSM095	Alpha Jobber Drill	9.5	1	
TLADBSM0100	Alpha Jobber Drill	10.0	1	
TLADBSM0105	Alpha Jobber Drill	10.5	1	
TLADBSM0110	Alpha Jobber Drill	11.0	1	
TLADBSM0115	Alpha Jobber Drill	11.5	1	
TLADBSM0120	Alpha Jobber Drill	12.0	1	
TLADBSM0125	Alpha Jobber Drill	12.5	1	
TLADBSM0130	Alpha Jobber Drill	13.0	1	



ACCESSORIES



FASTENERS

SCREWS

		PRODUCT CODE	DESCRIPTION	SIZE	QTY	ORDER QTY
FINE		FASGF625	Screw Gyp Fine	6x25	1000	
		FASGF630	Screw Gyp Fine	6x30	1000	
		FASGF640	Screw Gyp Fine	6x40	1000	
COARSE		FASGC625	Screw Gyp Coarse	6x25	1000	
		FASGC630	Screw Gyp Coarse	6x32	1000	
		FASGC632C	Screw Gyp Coarse Collated	6x32	1000	
		FASGC635	Screw Gyp Coarse	6x35	1000	
		FASGC640	Screw Gyp Coarse	6x40	1000	
		FASGC750	Screw Gyp Coarse	7x50	1000	
KWIKSEAL		FASGK30	Kwikseal Screw Gyp	30	1000	
		FASGK30C	Kwikseal Screw Gyp Collated	30	1000	
		FASGK41	Kwikseal Screw Gyp	41	1000	
		FASGK41C	Kwikseal Screw Gyp Collated	41	1000	
WAFER		FASWFH1016	Wafer Screw	10gx16	1000	
		FASWH81812	Wafer Screw Flat Head	8.18x12	1000	
ALUMINIUM SCREWS		FASSTP658	Screw S/Tap Pozi	6x5.8	100	
		FASSTP858	Screw S/Tap Pozi	8x5.8	100	
		FASSQT83216	Screw SQ Drive Tek	16x8.32	100	
EYE SCREWS		FASTE125	Screw Timber Eye	125mm	100	
		FASTE15	Screw Timber Eye	75mm	100	



ACCESSORIES



FASTENERS

SCREWS

RIVET		PRODUCT CODE	DESCRIPTION	SIZE (mm)	QTY	ORDER QTY
		FAR32100WHT	Rivet 3.2x10mm	White	1000	
		FAR32127	Rivet 3.2x12.7mm	Plain	1000	
		FAR32127WHT	Rivet 3.2x12.7mm	White	1000	
		FAR3242WHT	Rivet 3.2x4.2mm	White	1000	
		FAR3264	Rivet 3.2x6.4mm	Plain	1000	
		FAR3264BLK	Rivet 3.2x6.4mm	Black	1000	
		FAR3264WHT	Rivet 3.2x6.4mm	White	1000	
		FAR3282	Rivet 3.2x8.2mm	Plain	1000	
		FAR3282WHT	Rivet 3.2x8.2mm	White	1000	
		FAR3282BLK	Rivet 3.2x8.2mm	Black	1000	
FAR 40100WHT	Rivet 4x10mm	White	1000			

BATTERY POWERED

SCREW GUN		PRODUCT CODE	DESCRIPTION	QTY	ORDER QTY
		TLTSCREWGUNCL	Screw Gun Cordless Autofeed	1	
DRILL DRIVER KIT		TLTDRILLHAWX	Hawx Cordless Drill Driver Kit	1	

STAPLER+STAPLES

STAPLE GUN		PRODUCT CODE	DESCRIPTION	QTY	ORDER QTY
		TLTTACKER	H/D Hand Tacker	1	
STAPLES		FASTAPLESRAPID8	Rapid Staples N° 53 8mm	5000	
		FASTAPLESRAPID10	Rapid Staples N° 53 10mm	5000	
		FASTAPLESRAPID12	Rapid Staples N° 53 12mm	2500	
STAPLES		TLASTAPLES8	Staples 8mm	2850	
		TLASTAPLES10	Staples 10mm	2350	
		TLASTAPLES12	Staples 12mm	1850	



ACCESSORIES



FASTENERS

ANCHORS

MASONRY	PRODUCT CODE	DESCRIPTION	SIZE (mm)	QTY	ORDER QTY
	FAMSA6525	Masonry Suspension Anchor	6.5x25	100	
	FAMSA6535	Masonry Suspension Anchor	6.5x35	100	
	FAMSA660	Masonry Suspension Anchor	6x60	100	
	FAMSTWA660	Masonry Suspension Tie Wire Anchor	6x60	100	
	FAMWA625	Masonry Knock In Wall Anchor	6x25	100	
NYLON	FANA525	Nylon Anchor	5x25	1000	
	FANA6525	Nylon Anchor	6.5x25	100	
	FANA6538	Nylon Anchor	6.5x38	500	
	FANA6540	Nylon Anchor	6.5x40	500	
METAL	FAMSA522	Metal Anchor	5x22	100	
	FAMSA6532	Metal Anchor	6.5x32	100	
SLEEVE	FAMSLA840	Sleeve Anchor	M8x40	60	
	FAMSLA6525	Masonry Sleeve Anchor	6.5x25	100	

NITRO FITINGS

APEX FASTENERS AND FIXINGS	PRODUCT CODE	DESCRIPTION	QTY	ORDER QTY
	FASNCLIPSP332	Nitro Clip - Shank Pin 1-1/4"	1	
	FASNCLIPSS525L	Step Shank Pin W/Clip 1"	1	
	FASNCLIPSSP532L	Nitro Clip- Step Shank 1-1/4"	1	
	FASNPIN12219	Nitro Pin 1/2" 1 hole strap	1	
	FASNPIN1HS38219	Nitro Pin 3/8" 1 hole strap	1	
	FASNPIN219	Nitro 3/4" Track Pin	1	
	FASNPIN22W	Nitro Pin 7/8" x 125-washer	1	
	FASNPIN313W	Nitro Knerl Pin	1	
	FASNPIN319	Nitro Pin 3/4" x 0.145	1	
	FASTRH14	1/4" Threaded Rod Hangers	1	
	FASTRH38	3/8" Threaded Rod Hangers	1	





ACCESSORIES



ACCESSORIES

ACCESSORIES

SCREW TIPS		PRODUCT CODE	DESCRIPTION	SIZE (mm)	QTY	ORDER QTY
		TLASCREWT31	Screw Tip 31 Makita 6831	-	4	
		TLASCREWT32	Screw Tip 32 Makita 6832	-	4	
		TLASCREWT34	Screw Tip Makita 6834	146	4	
		TLASCREWT35	Screw Tip Makita 6833/35	132	4	
		TLASCREWT40	Screw Tip Makita 14.4V AR440	122	4	
		TLASCREWT55	Screw Tip Makita 18V AR550	157	4	

SCREW TIPS		TLASQDRIVER150	SQ Screw Driver Bit	150	1	
		TLASQDRIVER50	SQ Screw Driver Bit	50	1	
		TLAPHDRIVER150	No.2 Phillips Screw Driver Bit	150	1	
		TLAPHDRIVER50	No.2 Phillips Screw Driver Bit	50	1	

MAGNETIC HOLDER		TLABITHOLDER	Magnetic Holder	75	1	
-----------------	---	--------------	-----------------	----	---	--

MAGNETIC HOLDER		TLAGFB117	Magnetic Screw Philips Adapter/GFB-117 Drywall	25	1	
-----------------	---	-----------	--	----	---	--



ACCESSORIES



ACCESSORIES

HYDE PRODUCTS

PATCHES		PRODUCT CODE	DESCRIPTION	QTY	ORDER QTY
		TLTM0030	Crack Patcher HYDE	1	
		TLTM0003	Wet N Set Patch 5x15 HYDE	1	
		TLTM0002	SAD Wall Patch 6x6 HYDE	1	
		TLTM0001	SAD Wall Patch 4x4 HYDE	1	
CORNER ROLLER		TLTM0007	Corner Paint/Plaster Roller HYDE	1	
PROJECT TOOL		TLTM0031	14 N 1 Pro Project Tool HYDE	1	
SANDSCREEN		TLTM0032	Precut Drywall Sandscreen 180 Grit Medium 45 Mesh HYDE	2	
		TLTM0033	Precut Drywall Sandscreen 220 Grit Find 45 Mesh HYDE	2	



ACCESSORIES



ACCESSORIES

MISCELLANEOUS

ZIPWALL PRODUCTS		PRODUCT CODE	DESCRIPTION	QTY	ORDER QTY
		TLZWCPS320	Zipwall 3m Clear Poly Sheeting	1	
		TLZWCPS420	Zipwall 4m Clear Poly Sheeting	1	
		TLZWHDAZ2	Zipwall HD Adhesive Zippers	1	
		TLZWKIT20	Zipwall SL Poles 2m-6.4m	1	
		TLZWSLP1	Zipwall SL Poles 1.4m-3.8m	1	
		TLZWSLP2	Zipwall SL Poles 1.4m-3.7m	2	
		TLZWSLP4	Zipwall SL Poles 1.4m-3.7m	4	
		TLZWSLP4KIT	Zipwall Poles Kit 1.4m-3.2m	4	
		TLZWSLP6	Zipwall SL Poles 1.4m-3.7m	6	
		TLZWTPH1	Zipwall Head Replacement Pack	1	
		TLZWZIPZ2	Zipwall Std Adhesive Zippers	2	
		TLZWSIPF2	Foam Rails and Clips 1.5m	2	
CAUTION TAPE			Zipwall Caution Tape	1	
DANGER TAPE			Zipwall Danger Tape	1	
BUCKET		TLABUCKET	Porta Mix Bucket 40L	1	
JACK POLE		TLTJACK	Telescopic Jack	1	
BULBS		TLABULB	Halogen Bulb 500 Watt	1	
CAMLOCK STRAP		TLSLRAT6	Aerofast Light Ratchet Strap 6m x 37mm	1	
		TLSRAT6	Aerofast Ratchet Strap 6m x 50mm	1	
		TLSCAM3	Aerofast Camlock Strap 3m	1	









ACCESSORIES



ACCESSORIES

MISCELLANEOUS

CHALK		PRODUCT CODE	DESCRIPTION	QTY	ORDER QTY
		TLACHALKREFILL	Marking Chalk - Glo Orange	1	
		TLTCHALKLINE	Nylon Chalk Line 30m	1	
		TLTCHALKLINEZE	Zenten 30m Chalk Line w60g	1	
PENCIL		TLAPENCIL	Builders Pencil	1	
VACUUM		TLTM0023	Vacuum Hand Sander with Hose	1	
		TLTVAC1035	Starmix IPulse Series Dust Extrac Wet/Dry 35 Asbestos	1	
		TLTVAC1220	Starmix IPulse Series Dust Extrac Wet/Dry Plastic Cannister 20 L	1	
		TLTVAC1232	Starmix IPulse Series Dust Extrac Wet/Dry Plastic Cannister 32 L	1	
		TLTVAC1232	Starmix IPulse Series Dust Extrac Wet/Dry Pastic Cannister 25 L	1	
		TLTVAC1425	Starmix IPulse Series Dust Extract Wet/Dry Plastic Cannister 30 L	1	
		TLTVAC1430	Starmix IPulse Series Dust Extract Stainless Steel Cannister	1	
		TLTVAC1432	Starmix IPulse Series Dust Extractor Wet/Dry Plastic Cannister 32 L	1	
		TLTVAC1435	Starmix IPulse Series Dust Extractor Wet/Dry Plastic Cannister 35 L	1	
		TLTVAC1445	Starmix IPulse Series Dust Extrac Wet/Dry Plastic Cannister 45 L	1	
		TLTVAC1450	Starmix IPulse Series Dust Extrac Wet/Dry Plastic Cannister 50 L	1	
MIXER PADDLE		TLAMPADDLE	Mixer Paddle 130mm	1	
		TLTBOSGUN	Bostik Cartridge/Sausage Gun	1	
TELESCOPIC JACK		TLTJACK	Telescopic Jack	1	



WELLINGTON TEAM



Graham Dawson

Territory Manager, Lower North Island

/t/ 04 499 5915

/f/ 04 499 5916

/m/ 021 599 454

/t/ 0800 666 556

/e/ graham@tr-interiorsystems.co.nz



Rose Greally

Architectural Consultant

/t/ 09 571 0395

/f/ 09 571 0376

/m/ 021 248 6947

/t/ 0800 666 556

/e/ rose@tr-interiorsystems.co.nz

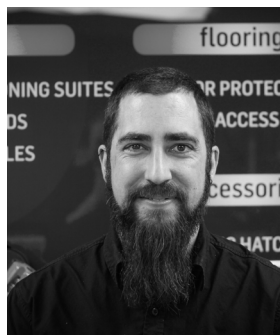

Hugo Liebert

Wellington Logistics

/t/ 09 571 0395

/f/ 09 571 0376

/m/ 021 075 1250

/t/ 0800 666 556

/e/ buy@tr-interiorsystems.co.nz



Mike Haworth

Warehouse, Shop and Logistics Coordinator

/t/ 09 571 0395

/f/ 09 571 0376

/m/ 021 222 1537

/t/ 0800 666 556

/e/ mike@tr-interiorsystems.co.nz



Contact [T&R Interior Systems](#) about Shipping Containers.



Current research shows a significant need to reduce the amount of hardcopy resources in favour of eco friendly online recourses for both architects and designers. T & R Interior Systems recognises this need and are happy to be able to offer the following resource options:



www.tris.co.nz and www.acoustic-solutions.co.nz

Our online resources include datasheets, technical information, DWG files, Revit files, Brochures and industry specific eBooks. Our product range includes suspended ceiling and interior wall systems, steel stud, Eclipse Office Partitioning Suite, acoustic panels and thermal and acoustic insulation.

www.masterspec.co.nz

Masterspec is the leading specification systems in New Zealand's construction industry used by over 1200 design practices. Available on two operating systems. Masterspec provides detailed specification resources that can easily be modified to suit any project. Masterspec delivers Standard, Structural and Civil Services, Landscapes, Basic Interiors and Minor Residential, accepted as the most efficient and reliable industry-standard solution available for design professionals. Making it easy to specify T & R products for your next project.

www.eboss.co.nz

EBOSS, the online technical library for the building and construction industries. Designed by design professionals for design professionals. Our goal is to provide you with the information you require, when you need it and in the format that best suits your needs. EBOSS has the complete range of T & R Interior Systems suspended ceiling tiles, acoustic sound panels, aluminium partition suites and steel framing available with technical information.



NOTES





NOTES





NOTES





NOTES



creating quality ambient spaces

Wellington Head Office
12 Glover St, Ngauranga
Wellington 6035
PO Box 38533
Wellington Mail Centre 5045
/t/ 04 499 5915

Auckland
19 - 21 Fairfax Ave,
Penrose, Auckland 1061
PO Box 112360,
Penrose, Auckland 1642
/t/ 09 571 0395

Christchurch
69 Disraeli St, Addington
Christchurch 8023
PO Box 7197
Christchurch 8240
/t/ 03 366 2507